

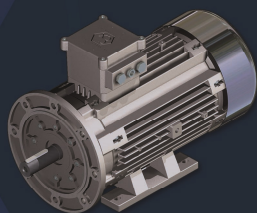

RL Series
IEC 56-160 Aluminium

TUBE Series
56-71 Aluminium

Ex d IIB
Ex d IIC
Ex de IIC
Ex t



 **RAEL** MOTORI
ELETTRICI



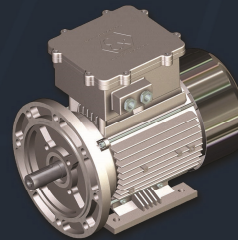
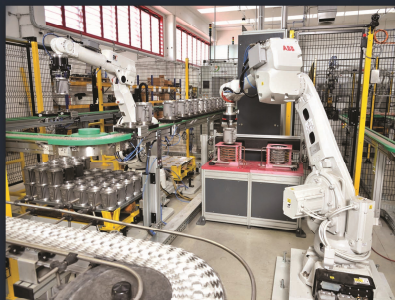
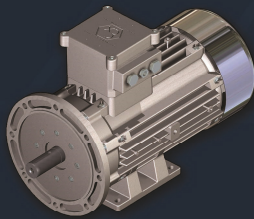
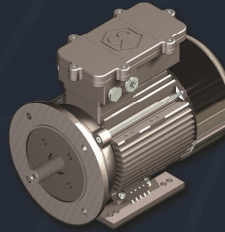
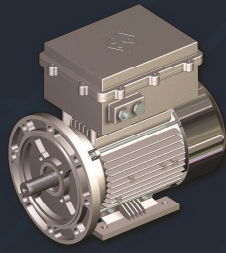

RAEL, founded in Genoa in 1969 as an electric motors repair and rewinding company, has grown to become an established name in projection and manufacture of electric motors for potentially explosive atmospheres.

Since 1986 the company has grown considerably and moved to Predosa [AL] where both production and offices are actually located.

Through constant research of products which can offer a high quality standard and market competitiveness we are geared up with automated production system like CNC turning and last generation machining centers, industrial robots, CNC grinding machine, inspection room with CMM machines, Computer controlled system for inline electrical test and Dynamometric braking test bench, automated assembly lines.

We offer a great flexibility in fulfilling special customer requirements.

All of the above helped to place Rael among the leading producers of Explosion proof motors.



CONTENTS

1. INTRODUCTION	4
1.0 SI Units.....	4
1.1 Standards of reference.....	5
1.2 Tolerances	6
1.3 Hazardous places.....	7
1.4 Temperature Classes	9
1.5 Electric motor choice	12
2. GENERAL INFORMATION	13
2.1 Range of Motors.....	13
2.2 Main features	14
2.3 Main Options	14
3. TERMINAL BOX	16
3.1 Possible versions	16
3.2 Tube Motors	17
3.3 Cable entries and terminals.....	18
3.4 Connecting diagrams	19
4. MECHANICAL CHARACTERISTIC	20
4.1 Mounting arrangements	20
4.2 Materials.....	21
5. ELECTRICAL DATA	22
5.1 Three phase motors 1 speed and for inverter	22
5.2 Three-phase motors 2 speed – Constant Torque.....	27
(for general purpose).....	27
5.3 Three-phase motors 2 speed - Quadratic Torque	31
(For centrifugal machines).....	31
5.4 Single-phase motors	35
6. OVERALL DIMENSIONS	36
6.1 Three-phase motors	36
6.2 Forced Ventilation Motors	37
6.3 Single-phase motors	37
6.4 Tube Series.....	38
6.4 Terminal box	39
7. SPARE PARTS	40
7.1 Personnel qualification	40
7.2 List of spare parts.....	40



1. INTRODUCTION

1.0 SI Units

Base units

Base quantity	Base quantity symbol	SI Name	SI Symbol
length	l	meter	m
mass	m	kilogram	kg
time	t	second	s
electric current	I, i	ampere	A
thermodynamic temperature	T	Kelvin	K
amount of substance	n	mole	mol
luminous intensity	I_v	candela	cd

Derived units

Derived quantity	Derived quantity symbol	SI Name	SI symbol	Expression in terms of other SI units	Expression in terms of SI base units
frequency	hertz	Hz	-	-	s^{-1}
force	F	Newton	N	-	$kg \cdot m \cdot s^{-2}$
pressure, stress	p	Pascal	Pa	$N \cdot m^{-2}$	$kg \cdot m^{-1} \cdot s^{-2}$
energy, work, quantity of heat	E	joule	J	$N \cdot m$	$kg \cdot m^2 \cdot s^{-2}$
power	P, W	watt	W	$J \cdot s^{-1}$	$kg \cdot m^2 \cdot s^{-3}$
electric charge	q	coulomb	C		$A \cdot s$
electric potential difference, electromotive force	v	volt	V	$J \cdot C^{-1}$	$m^2 \cdot kg \cdot s^{-3} \cdot A^{-1}$
electric resistance	R	ohm	Ω	$V \cdot A^{-1}$	$m^2 \cdot kg \cdot s^{-3} \cdot A^{-2}$
electric conductance	G	siemens	S	$A \cdot V^{-1}$	$s^3 \cdot A^2 \cdot m^{-2} \cdot kg^{-1}$
capacitance	C	farad	F	$C \cdot V^{-1}$	$s^4 \cdot A^2 \cdot m^{-2} \cdot kg^{-1}$
magnetic flux density	B	tesla	T	$V \cdot s \cdot m^{-2}$	$kg \cdot s^{-2} \cdot A^{-1}$
magnetic flux	$\Phi(B)$	Weber	Wb	$V \cdot s$	$m^2 \cdot kg \cdot s^{-2} \cdot A^{-1}$
inductance	L	Henry	H	$V \cdot s \cdot A^{-1}$	$m^2 \cdot kg \cdot s^{-2} \cdot A^{-2}$
Celsius temperature	T	degree Celsius	$^{\circ}C$	K	
plane angle	φ, θ	radiant	rad	1	$m \cdot m^{-1}$
luminance		lux	lx	$cd \cdot sr \cdot m^{-2}$	

Other derived quantities

area	A				m^2
volume	V				m^3
speed, velocity	v				$m \cdot s^{-1}$
angular velocity	ω				s^{-1}
					$rad \cdot s^{-1}$
acceleration	a				$m \cdot s^{-2}$
Torque, moment of force	M			$N \cdot m$	$m^2 \cdot kg \cdot s^{-2}$
moment of inertia	J				$kg \cdot m^2$
mass density	ρ				$kg \cdot m^{-3}$
specific volume					$m^3 \cdot kg^{-1}$
dynamic viscosity	ρ			$N \cdot s \cdot m^{-2}$	$m^{-1} \cdot kg \cdot s^{-1}$
				$Pa \cdot s$	



1.1 Standards of reference

RAEL motors are constructed in compliance with the following standards:

Title	EU CENELEC	International IEC
Rotating electrical machines Part 1: Rating and performance	EN 60034-1	IEC 60034-1
Rotating electrical machines Part 2-1: Standard methods for determining losses and efficiency from tests (excluding machines for traction vehicles)	EN 60034-2	IEC 60034-2
Rotating electrical machines. Part 5: Degrees of protection provided by the integral design of rotating electrical machines (IP code). Classification	EN 60034-5	IEC 60034-5
Rotating electrical machines Part 6: Methods of cooling (IC Code)	EN 60034 -6	IEC 60034 -6
Rotating electrical machines Part 7: Classification of types of construction, mounting arrangements and terminal box position (IM Code)	EN 60034-7	IEC 60034-7
Rotating electrical machines Part 9: Noise limits	EN 60034-9	IEC 60034-9
Rotating electrical machines Part 12: Starting performance of single-speed three-phase cage induction motors	EN 60034-12	IEC 60034-12
Rotating electrical machines Part 14: Mechanical vibration of certain machines with shaft heights 56 mm and higher - Measurement, evaluation and limits of vibration severity	EN 60034-14	IEC 60034-14
General purpose three-phase induction motors having standard dimensions and outputs. Frame numbers 56 to 315 and flange numbers 65 to 740	EN 50347	IEC 60072-1
Degrees of protection provided by enclosures (IP Code)	EN 60259	IEC 60529
Electrical apparatus for explosive gas atmospheres Part 0: General requirements	EN 60079-0	IEC 60079-0
Electrical apparatus for explosive gas atmospheres Part 1: Flameproof enclosures 'd'	EN 60079-1	IEC 60079-1
Electrical apparatus for explosive gas atmospheres Part 7: Increased safety "e"	EN 60079-7	IEC 60079-7
Electrical apparatus for use in the presence of combustible dust Part 1: Protection by enclosures "t"	EN 60079-31	IEC 60079-31



1.2 Tolerances

Mechanical tolerances according to EN 50347 and IEC 60072-1:

Symbol	Description	Tolerance
A	Distance between centre-lines of fixing holes (end view)	± 1 mm
AB	Overall dimensions across the feet (end view)	+ 2 %
AC	Diameter of the motor (without terminal box)	+ 2 %
B	Distance between centre-lines of fixing holes (side view)	± 1 mm
C - CA	Distance from the shaft end shoulder to the centre-line of nearest mounting holes in the feet	± 3 mm
D - DA	Diameter of the shaft extension.	$\varnothing 11 - 28$ j6 $\varnothing 32 - 48$ k6 $\varnothing \geq 55$ m6
E - EA	Length of the shaft extension from the shoulder	$\varnothing < 55$ mm - 0,3 mm $\varnothing > 60$ mm + 0,5 mm
F - FA	Width of the keyway of the shaft extension	h9
GA - GC	Distance from the top of the key to the opposite surface of the shaft extension	+ 0,2 mm
H	Distance between the centre-line of the shaft to the bottom of the feet	$H \leq 250$ - 0,5 mm $H \geq 280$ - 1 mm
HD	Distance from the top of the terminal box and to the bottom of the feet	+ 2 %
K	Diameter of the holes or width of the slots in the feet of the motor	+ 3 %
L	Overall length of the motor with a single shaft extension	+ 1 %
M	Pitch circle diameter of the fixing holes	$\pm 0,8$ mm
N	Diameter of the spigot	$\varnothing < 230$ j6 $\varnothing \geq 250$ h6
P	Outside diameter of the flange	± 1 mm
R	Distance from the shaft shoulder to the mounting surface of the flange	± 3 mm
S	Diameter of the fixing holes in the mounting flange or nominal diameter of thread	+ 3 %
	Distance from the shaft shoulder to the mounting surface of the flange with locked bearing	$\pm 0,5$ mm
	Mass of the motor	- 5 a + 10 %

Electrical tolerances according to EN 60034-1 and IEC 60034-1:

Quantity	Tolerance
Efficiency (η)	- 0,15 (1- η) for $P_N \leq 50$ kW
Total losses	+10%
Power factor (Cos φ)	$\frac{1-\cos\varphi}{6}$ minimum absolute value 0,02 maximum absolute value 0,07
Slip (rpm) (at full load and working temperature)	$\pm 30\%$ per $P_N < 1$ kW $\pm 20\%$ per $P_N \geq 1$ kW
Locked rotor current (I_A)	+ 20%
Locked rotor torque (T_A)	-15% a +25%
Breakdown torque (T_{max})	-10% (for this tolerance the value T_{max}/ T_n should be at least 1,6)
Moment of Inertia (J)	$\pm 10\%$
Sound intensity level (sound pressure)	+3 dB (A)



1.3 Hazardous places



1.3.1 General information

DIRECTIVE 1999/92/EC on minimum requirements for improving the safety and health protection of workers potentially at risk from explosive atmospheres.

'Explosive atmosphere' means a mixture with air, under atmospheric conditions, of flammable substances in the form of gases, vapours, mists or dusts in which, after ignition has occurred, combustion spreads to the entire unburned mixture.

The directive gives information regarding '**Classification of places where explosive atmosphere may occur**'.

The classification of hazardous places in zones competes to the customer whose working centres and activities contain or give place to such dangers.

The safety against explosion can be only reached with the contribution, and the mutual informative exchange, both the manufacturer and the final users.

INDICATIONS REGARDING THE CLASSIFICATION OF PLACES WHERE EXPLOSIVE ATMOSPHERES MAY OCCUR

For the classification of the areas reference to the relative harmonized technical norms regarding the specific fields:

- EN 60079-10 (IEC 60079-10) Electrical apparatus for explosive gas atmospheres.
Part 10: Classification of hazardous areas.
- EN 61241-10 (IEC61241-10) Electrical apparatus for use in the presence of combustible dust
Part 10: Classification of areas where combustible dusts are or may be present.

Zone 0

A place in which an explosive atmosphere consisting of a mixture with air of flammable substances in the form of gas, vapour or mist is present continuously or for long periods or frequently.

Note: In general, said conditions, when they present, they interest the inside of tanks, tubes and containers, etc.

Zone 1

A place in which an explosive atmosphere consisting of a mixture with air or flammable substances in the form of gas, vapour or mist is likely to occur in normal operation occasionally.

Note: such zone can also comprise:

- places in the immediate vicinities of zone 0;
- places in the immediate vicinities of the feeding openings;
- places in the immediate vicinities of the filling openings and emptying;
- places in the immediate vicinities of apparatuses, systems of protection and fragile components of glass, ceramics and analogous materials;
- places in the immediate vicinities of glands not sufficiently sealing, as an example on pumps and valves with glands.

Zone 2

A place in which an explosive atmosphere consisting of a mixture with air of flammable substances in the form of gas, vapour or mist is not likely to occur in normal operation but, if it does occur, will persist for a short period only.

Note: such zone can also comprise, surrounding places zones 0 or 1.

Zone 20

A place in which an explosive atmosphere in the form of a cloud of combustible dust in air is present continuously, or for long periods or frequently.

Note: In general, said conditions, when they present, they interest the inside of tanks, tubes and containers, etc.

Zone 21

A place in which an explosive atmosphere in the form of a cloud of combustible dust in air is likely to occur in normal operation occasionally.

Note: such zone can also comprise, for example, places in the immediate vicinities of loading points and powder emptying and places in which powder layers are formed or that, during the normal operation, could produce one explosive combustible powder concentration in mixture with the air.

Zone 22

A place in which an explosive atmosphere in the form of a cloud of combustible dust in air is not likely to occur in normal operation but, if it does occur, will persist for a short period only.

Note: such zone can also comprise, places in proximity of apparatuses, systems of protection and components containing powders, from which the powders can leak out because of losses and to form layers of powders (for example salt from milling, in which the powder leak from the mills and it is deposited).

Notes:

1. Layers, deposits and heaps of combustible dust must be considered as any other source which can form an explosive atmosphere.
2. 'Normal operation' means the situation when installations are used within their design parameters.



1.3.2 Classification of the equipment for areas where explosive atmosphere may occur

GROUPS AND CATEGORIES OF APPARATUSES

Within the directive 2014/34/EU, the apparatuses, comprised if necessary the devices and the components are divided in two groups.

Group I comprises equipment intended for use in the underground parts of mines, and to those parts of surface installations of such mines, likely to become endangered by firedamp and/or combustible dust.

It is sub-divided into 2 Categories, as shown below:

- Category M1:** very high level of protection
- Category M2:** high level of protection

Group II comprises equipment intended for use in other places likely to become endangered by explosive atmospheres. It is sub-divided into 3 Categories, as shown below

- Category 1:** very high level of protection
- Category 2:** high level of protection
- Category 3:** normal level of protection

For the type of protection "d", "I", "nC" and "nL", the electrical apparatus of Group II are subdivided in IIA, IIB and IIC, like prescribed in the relative specific European Norms regarding these types of protection.

How much higher is the possibility that an explosive atmosphere can take place, much higher must be the level of the adopted safety measures.

CRITERIA FOR THE CHOICE OF THE APPARATUSES AND THE SYSTEMS OF PROTECTION

In case the document on the protection against explosion based on the risk assessment does not preview otherwise, in all the areas in which explosive atmospheres can be formed are used apparatuses and systems of protection correspondents to the categories as per directive 2014/34/EU.

In particular, in such areas the following categories of apparatuses are used, provided that adapted, to second of the cases, to gas, vapours or fogs and/or powders:

- in zone 0 or zone 20, apparatuses of category 1;
- in zone 1 or zone 21, apparatuses of category 2;
- in zone 2 or zone 22, apparatuses of category 3;

Below you can find an outline for the choice of means of protection in function of the use zone.

GRUOP	CATEGORY	Means of protection			Explosive atmosphere presence	Zone
		Level	Characteristic of protection (AII. I)	Characteristic of protection (AII. II)		
II	1	Very high	In case of breakdown of means of protection, the level of safety is guaranteed from at least a second independent mean of protection. Moreover, the level of safety is guaranteed even if two independent anomalies are manifested	They must be planned and manufactured so that the sources of ignition are not activated, not even in case of exceptional anomalies of the apparatus	continuously or for long periods	0 1 2 20 21 22
	2	High	The level of safety is guaranteed also in presence of recurrent anomalies or defects of operation of the apparatuses of which it is habitually necessary to hold account.	They must be planned and manufactured so as to avoid sources of ignition, also in case of recurrent anomalies or defects of operation of the apparatuses of which it is habitually necessary to hold account.	Intermediate situation between previous and the successive one	1 2 21 22
	3	Normal	The level of safety is guaranteed in the normal operation.	They must be planned and manufactured so as to avoid sources of ignition expectable during the normal operation.	Scarce probability and if it take place is of short duration	2 22



1.4 Temperature Classes

1.4.1 Explosive atmosphere consisting of a mixture with air of flammable substances in the form of gas, vapour or mist (GAS)

Ignition temperature of an explosive gas atmosphere

Lowest temperature of a heated surface which, under specified conditions according to IEC 60079-4, will ignite a flammable substance in the form of a gas or vapour mixture with air.

Maximum surface temperature

Highest temperature which is attained in service under the most adverse conditions (but within the specified tolerances) by any part or surface of an electrical apparatus, which would be able to produce an ignition of the surrounding explosive atmosphere.

Group II electrical apparatus, in function of their maximum surface temperature shall be marked either classified in a temperature class given in Table below:

**Classification of maximum surface temperatures
for Group II electrical apparatus**

Temperature class	Maximum surface temperature (°C)
T1	450
T2	300
T3	200
T4	135
T5	100
T6	85

The maximum surface temperature shall not exceed the lowest ignition temperature of the explosive atmospheres concerned.

As far as the electric motors the maximum surface temperature will be referred to the temperature of:

the **external surface** of the enclosure as far as the *Flameproof enclosures 'd'* (EN 60079-1, IEC 60079-1) and *Equipment protection by pressurized enclosures 'p'* (EN 60079-2, IEC 60079-2)

all the surfaces both external and internal as far as the *Increased safety "e"* (EN 60079-7, IEC60079-7) and the *Construction, test and marking of type of protection 'n' electrical apparatus* (EN 60079-15, IEC 60079-15).

Below there is a representing table of the main inflammable gas substances divided by group of gas with relative temperatures of ignition and classes of temperature.



Main inflammable substances subdivided for group of gas (IIA, IIB, IIC) and temperature of ignition.

Inflammable substance	Group of GAS	temperature of ignition	Class of Temperature (°C)	Inflammable substance	Group of GAS	temperature of ignition	Class of Temperature (°C)
2-Methylpentane	IIA	300	T2	Ethyl formate	IIA	440	T2
Amyl acetate	IIA	360	T2	Methyl formate	IIA	450	T1
Butyl-n acetate	IIA	425	T2	Natural gas	IIA	482	T1
Ethyl acetate	IIA	426	T2	Isobutane	IIA	460	T1
Isobutil acetate	IIA	420	T2	Isoheptane	IIA	220	T3
Methyl acetate	IIA	502	T1	Isohexane	IIA	264	T3
Propil acetate	IIA	430	T2	Isooctane	IIA	410	T2
Vinyl acetate	IIA	425	T2	Isoprene	IIA	220	T3
Acetone	IIA	465	T1	Methane	IIA	537	T1
Methanol	IIA	464	T1	Methylcyclopentane	IIA	258	T3
Bromethane	IIA	511	T1	Methylamine	IIA	430	T2
Butane	IIA	287	T3	Methylmetacrylate	IIA	430	T2
Butene - 1	IIA	384	T2	Paraldehyde	IIA	239	T3
Butene - 2	IIA	325	T2	Pentane	IIA	258	T3
Cycloexano	IIA	259	T3	Pyridine	IIA	483	T1
Cycloexanol	IIA	300	T2	Propane	IIA	470	T1
Cyclohexanone	IIA	419	T2	Propylamine	IIA	318	T2
Cyclohexene	IIA	244	T3	Propylbenzene	IIA	450	T1
Cyclopropane	IIA	498	T1	Propylene	IIA	455	T1
Cymene (p)	IIA	436	T2	Styrene	IIA	490	T1
Chloro-benzene	IIA	637	T1	Toluene	IIA	480	T1
Acetyl chloride	IIA	390	T2	m-Xylene	IIA	522	T1
Allyl chloride	IIA	390	T2	o-Xylene	IIA	464	T1
Chlorbutane	IIA	240	T3	p-Xylene	IIA	528	T1
Chloroethane	IIA	495	T1	1,2 Butadiene	IIB	430	T2
Vinyl chloride	IIA	472	T1	1,3 Butadiene	IIB	430	T2
Dichlorobenzene	IIA	648	T1	Dioxane	IIB	245	T3
Dichloroethylene 1,1	IIA	570	T1	Diethyl ether	IIB	160	T4
Dichloroethylene 1,2	IIA	441	T2	Ethyl vinyl ether	IIB	200	T3
Diethylamine	IIA	312	T2	Methyl vinyl ether	IIB	350	T2
Dimethylamine	IIA	400	T2	Acrylate ethyl	IIB	350	T2
Dimethylaniline	IIA	371	T2	Ethylene	IIB	425	T2
Dimethylbutane 2,3	IIA	405	T2	LPG	IIB	365	T2
Dimethylpentane 2,3	IIA	330	T2	Sulphurated Hydrogen	IIB	260	T3
Heptane	IIA	215	T3	Methylacrylate	IIB	415	T2
Hexane	IIA	233	T3	Carbon monoxide	IIB	605	T1
Heptane	IIA	515	T1	Ethylene oxide	IIB	435	T2
Ethylacetoacetate	IIA	350	T2	Propylene oxide	IIB	430	T2
Ethylamine	IIA	385	T2	Acetylene	IIC	305	T2
Ethylmercaptane	IIA	295	T3	Hydrogen	IIC	500	T1
Butyl formate	IIA	320	T2	Carbon disulfide	IIC	95	T6



1.4.2 Explosive atmosphere in the form of a cloud of combustible dust (DUST)

We take in consideration protection by enclosures "t" (*Ex t*). The ignition protection is based on the limitation of the maximum surface temperature of the enclosure and on other surfaces which could be in contact with dust and on the restriction of dust ingress into the enclosure by the use of "dust-tight" or "dust-protected" enclosures.

The choice of these constructions so to avoid primes due to excessive surface temperatures must be carried out in function of the limits of temperature of ignition for the presence of flammable dust both in form of clouds and layers.

In case of presence of flammable dust cloud, the maximum surface temperature will be

$$T_{\max(1)} = 2/3 \cdot T_{cl} \quad \text{with } T_{cl} \text{ ignition temperature in } ^\circ\text{C} \text{ of the dust cloud.}$$

While in case of presence of a flammable dust layer:

$$T_{\max(2)} = T_l - 75 \text{ } ^\circ\text{C} \quad \text{with } T_l \text{ ignition temperature in } ^\circ\text{C} \text{ of a layer of dust 5 mm thick.}$$

The surface temperature must be smaller or equal to the minimum value between $T_{\max(1)}$ e $T_{\max(2)}$.

Main inflammable substances (DUST) and their own maximum surface temperature

Substance	Medium largeness particles (μm)	LEL (g/m^3)	Cloud ignition temperature T_{cl} ($^\circ\text{C}$)	Layer 5mm thick ignition temperature T_l ($^\circ\text{C}$)
Metals, alloys				
Aluminium	10	60	560	430
Bronze	18	750	390	260
Iron	12	500	580	>450
Graphite	7	30	600	680
Lamp-black (carbon black)	13	15	620	435
Sulphur	20	30	280	260

Wood, products of wood, fibres				
Paper		100	620	370
Cellulose (93% sweet wood, 6% hard wood)	14	15	420	335
wood flour	60		470	305
Wood (50% pear tree and 50% kernel)	35	100	500	340
Wood (beech)	61		490	310
Wood (pear tree)	27	100	500	320
Sawdust of wood	65		470	290
Cork	42	30	470	300

Agricultural products				
Cacao	3	125	460-540	245
Coffee	10	25	360	450
Cereals (mixed powders)	37	125	510	300
Wheat flour	56-125	60	480	>450
Soy flour	20	200	620	280
Gelatine	65	60	560	>450
Wheat		100	470	220
Dry milk	165	60	460	330
Milk sugar	22	60-125	450	>450
Rye			415-470	325
Buttermilk	400		450	420
Tobacco		60	485	290
Black tea	76	125	510	300
Sugar	32	30	360	>450
Powdered sugar	17	60	350	>450



1.5 Electric motor choice

After speaking about classification of areas with explosion atmosphere, motor groups , categories and temperature classes , we can switch to the choice of the type of protection of the motor and the reading of the motor marking.

Explosive atmosphere type				Motor Marking					
	Area Classification	Presence of explosive atmosphere	Protection	Group	Category	Type of Protection	Gas Group	Temperature Class	IP degree
GAS	Zone 1	Probable	High	II	2G	Ex d (Ex de on request)	IIC IIB (d)	T4 (T5 e T6 on request)	-
	Zone 2	Improbable	Normal	II	2G	Ex d (Ex de on request)	IIC IIB(d)	T4 (T5 e T6 on request)	-
POLVERI	Zone 21	Probable	High	II	2D	Ex t	-	T135°C (T100°C e T85°C on request)	IP6x
	Zone 22	Improbable	Normal	II	2D	Ex t	-	T135°C (T100°C e T85°C on request)	IP6x

<p> PTC <input type="checkbox"/> N° 0000001 Year 2015 Type RL80B4 (RL0015) Cl. F S1 Kg 12 V(±5%) Hz kW A rpm cosφ Ia/In 230/400 50 0.75 3,46 / 2 1410 0.8 4.9 DO NOT OPEN WHILE ENERGIZED Ta -20°C +50°C IP66 II 2G Ex de IIC T4 Gb II 2D Ex tb IIIC T135 Db </p>	CE Xxxx	Marking of conformity in compliance with European Directives. Number of Notified body that issued the Product Quality Assurance Notification
		Marking of conformity to the Directive 2014//34/EU and the relevant technical rules
	II	Explosion Group (surface plants different from mines)
	2	Category
	G	Type of explosive atmosphere: Gas, Vapour or Mist
	D	Type of explosive atmosphere: Dust
	Ex	Symbol for security appliances that meets a certain protection mode
	D	Explosion proof enclosure
	d o e	Explosion proof terminal box / Increased safety terminal box
	tb	Motors with dust protection zone 21 (and zone 22)
	IIC	Gas group (II C Hydrogen and Acetylene)
	IIIC	Dust group
	T4 - T5 - T6	Motor temperature class suitable for flammable substance temperature class in case of protection G (Gas)
	T135°C - T100°C - T85°C	Motor temperature class suitable for flammable substance temperature class in case of protection D (Dust)
	AB xx ATEX yyy	AB : Name of the body that released CE type certificate xx : year of production yyy : certificate number
	IPXX	Protection degree to be marked on the nameplate for D version
°C amb	Temperature rage	
Gb	Gas protection degree	
Db	Dust protection degree	

- Motors for zones 21 and 22 have protection type Ex t (DUST) matched with protection type Ex d (or Ex de) (GAS).
- On request it is possible to have motors Ex de with motor 'd' and increased safety terminal box 'e'.
- Motors marked with gas group IIC are suitable to be used where gas groups IIB or IIA are requested.
- Single-phase motors with internal capacitors can be marked IIC and IIB and are suitable also for IIA (see page 34) .
- Motors with temperature class T4 (gas) are suitable to be used where temperature classes T3, T2, T1 are requested. (On request it is possible to have temperature classes T5 e T6).
- IP degree protection is IP55 for GAS and IP66 for DUST.
- Ambient temperature range is as follows:
 -20° +60°C for temperature class T4 and surface temperature T135°C (possible to have -40° +60°C IIB version)
 -20° +50°C for temperature class T5 and surface temperature T100°C (possible to have -40° +60°C IIB version)
 -20° +40°C for temperature class T6 and surface temperature T85°C (possible to have -40° +60°C IIB version)



2. GENERAL INFORMATION

2.1 Range of Motors

Motors RL series are manufactured in compliance with all the European standards concerning equipment and protective systems for potentially explosive atmosphere in compliance with the European Directive ATEX 2014/34/EU (better known as ATEX).

As we just told in part 2.0 to be in compliance with ATEX Directive are necessary:

- EC type Certificate
- Product Quality assurance Notification

Such certificates are issued by notified bodies qualified to release them.

Motors RL series group II category 2G (GAS) with IP%% protection are suitable for zone 1 and zone 2, while the motors group II category 2D (DUST) with protection IP66 are suitable also for zone 21 and zone 22.

Version	Frame size (mm)	Power (kW)	Poles	GAS Group	Temperature Class 2G motors	Surface temperature 2D motors	Ambient Temperature
Three phase - 1 speed 2 - 4 - 6 - 8 poles	56 - 160	0,06 - 18,5	2	IIC IIB	T4 (a) T4/T5/T6	T 135 °C (a) T135-T100-T85°C	-20°C a +60°C (c) -40°C a +60°C
		0,06 - 15	4				
		0,035 - 11	6				
		0,06 - 7,5	8				
Three phase - 2 speeds (Constant Torque), 2/4 - 4/8 - 4/6 - 6/8 poles	63 - 160	0,25/0,18 - 15/12	2/4	IIC IIB	T4 (b) T4/T5	T 135 °C (b) T135-T100	-20°C a +60°C -40°C a +60°C
		0,18/0,09 - 10/6,6	4/8				
		0,2/0,1 - 8,8/5,9	4/6				
		0,08/0,12 - 5,5/4	6/8				
Three phase - 2 speeds (Quadratic Torque), 2/4 - 4/8 - 4/6 - 6/8 poles	63 - 160	0,25/0,06 - 16/4,4	2/4	IIC IIB	T4 (b) T4/T5	T 135 °C (b) T135-T100	-20°C a +60°C -40°C a +60°C
		0,25/0,05 - 12/3,2	4/8				
		0,3/0,1 - 11/3,3	4/6				
		0,33/0,09 - 7,5/4	6/8				
Three-phase for Inverter 2 - 4 - 6 - 8 poles	56 - 160	0,06 - 18,5	2	IIC IIB	T4 T4	T 135 °C T 135 °C	-20°C a +60°C -40°C a +60°C
		0,06 - 15	4				
		0,035 - 11	6				
		0,06 - 7,5	8				
Single-phase 2 - 4 - 6 poles	56 - 100	0,06 - 3	2	IIB ^(d) IIB ^(e)	T4 T4	T 135 °C T 135 °C	-20°C a +40°C -40°C a +60°C
		0,06 - 1,6	4				
		0,06 - 1,1	6				

(a) Available also in version T5 (T100°C) and T6 (T85°C) on request

(b) Available also in version T5 (T100°C) on request

(c) Available in version T6 (T85°C) the ambient temperature range is -20°C +40°C

(d) Available also IIC (frame 56-63-71 see page 36 and with D terminal box at page 40)

(e) Available also IIB with increased safety "e" terminal box (frame 56-63-71 see page 36 and with D terminal box at page 40)



2.2 Main features

Motors RL comply with the Essential Health and Safety Requirements for potentially explosive atmospheres provided by European Standards: EN 60079-0, EN 60079-1, EN 60079-7, EN 61241-0, EN 61241-1, EN 60529.

- Three-phase and single-phase squirrel cage asynchronous induction motors.
- Aluminium modular motors, flanges and feet can be assembled and disassembled.
- Type of protection  Ex d, Ex de, Ex t.
- Overall dimensions comply with IEC 60072 and EN 50347.
- Ventilations **IC 411** (Self ventilated).
- Voltage 230/400 V \pm 5% Δ/Y (56 - 112), 400/690 V \pm 5% Δ/Y (132 - 160), frequency 50 Hz \pm 2%.
- Insulation Class F.
- Protection degree IP55 for zone 1 and zone 2, IP66 for zone 21 and zone 22.
- Maximum noise level 80 dB (A).
- Terminal box (see 3.1):
 - Version Ex d IIC
 - Version Ex e IIC
 - Version without terminal box, motor comprehensive of cable
 - Version Ex d IIB terminal box **A**
(for single-phase - 1 capacitor)
 - Version Ex d IIB terminal box **B**
(for high torque single-phase - 2 capacitors, starting system, soft-starter, poles commutation system)
 - Version Ex d IIB terminal box **C**
(Motor provided with contactor system for starting, soft-starter, contactor system for pole commutation)
- Fan cover in sheet steel.
- Low friction dust seals.

2.3 Main Options

Motors Versions

- Motors 2D protection degree IP66 suitable for zone 21 and zone 22.
- Special Powers on frames 132 and 160
- Motors without ventilation (**IC 410**).
- Motors with forced ventilation (**IC 416**).
- Single phase version Ex d IIB with high starting torque (1 run capacitor – 1 start capacitor).
- Motors with starting system inside the terminal board.

Electrical and mechanical variants

- Special voltage and frequency.
- Thermal protectors (probe PTC or PTO).
- Anti-condensation heaters.
- Insulation class H.
- Motors tropicalized.
- Motors suitable for frequency inverter drive.
- Double shaft motors.
- Special shaft for ENCODER.
- Special shafts.
- Special flanges.
- Motor without terminal box with cable (length on request).
- Terminal box on the side (right or left).
- Terminal box with special cable glands.
- Increased safety 'e' terminal box.
- Terminal box type A, B, C for special purpose (it is possible to have single-phase motors with frame 112 and box C).
- Protection IP66.
- Temperature class T5 e T6.
- Fan cover + rain cover.
- Special bearings.
- Locked front bearing.
- **Tube version specially designed for ATEX axial fan (see 3.2)**

Tests

All RAEL motors are 100% tested, both at the beginning (winding test) and at the end of production (motor electric test).

On request additional tests on the motors can be performed:

- Standard test "Routine Test".
- Heating test.

Forced Ventilation (IC416)

Cooling is provided by an auxiliary Ex motor, fitted in the back of the main motor. In RL series it is a 56 frame single or three phase motor.

The user shall use an electric device that enables the main motor to run only when the auxiliary motor is already running.

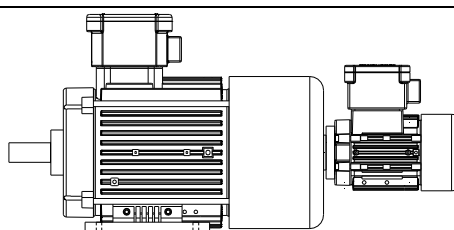



3. TERMINAL BOX

3.1 Versions

a. Three phase version Ex d IIC and three phase version Ex e IIC increased safety "e"

	<p>Wiew from the shaft</p> <p>The standard position of terminal box is A – 1 with box on the top and cable outlet in the back It is possible to have the box on the sides (position B or C) and the cable outlet in the positions 2, 3 e 4</p>
--	--

b. Motor without terminal box comprehensive of cable. Three phase version Ex d IIC

	<p>Wiew from the shaft</p> <p>The standard position is A but It is possible to have the cable outlet on the side (B o C)</p>
--	---

c. Motor with terminal box A Version Ex d IIB

Application: single phase motor with internal run capacitor

	<p>Wiew from the shaft</p> <p>The standard position is A but It is possible to have the cable outlet on the side (B o C)</p>
--	---

d. Motor with terminal box B Version Ex d IIB

Application: - single phase motor with high starting torque with internal run and start capacitor
- motor provided with contactor system for starting, soft-starter, pole commutation system

	<p>Wiew from the shaft</p> <p>The standard position is A but It is possible to have the cable outlet on the side (B o C)</p>
--	---

e. Motor with terminal box C Version Ex d IIB

Application: motor provided with contactor system for starting, soft-starter, contactor system for pole commutation

	<p>Wiew from the shaft</p> <p>The standard position is A but It is possible to have the cable outlet on the side (B o C)</p>
--	---

3.2 Tube motors

Tube motors have been specifically designed with axial fan manufacturers in mind.

Being a direct evolution of the RL series, they maintain the same features of the main RL series:

- interchangeable and removable mounting arrangements: B3, B5, B14, B30, B34, B35
- Same protection degrees : Ex d, Ex de, Ex t.

Tube motors differ from standard RL series motors due to their lower profile, allowing ideal airflow in a duct fan configuration.

Terminal box has been repositioned in the back side of the motor providing multiple choice in terms of cable output position, both in-axe and perpendicular.

Tube series motors are available in 56,63 and 71 frames with B3, B5, B14 and B34, B35, B30 mounting arrangements. Tube series can be personalized on customer's request.

For electrical data please consult three and single phases RL motors data up to frame size 71.

Cable Output Positions

a. Top

With or without cable gland/ cable.

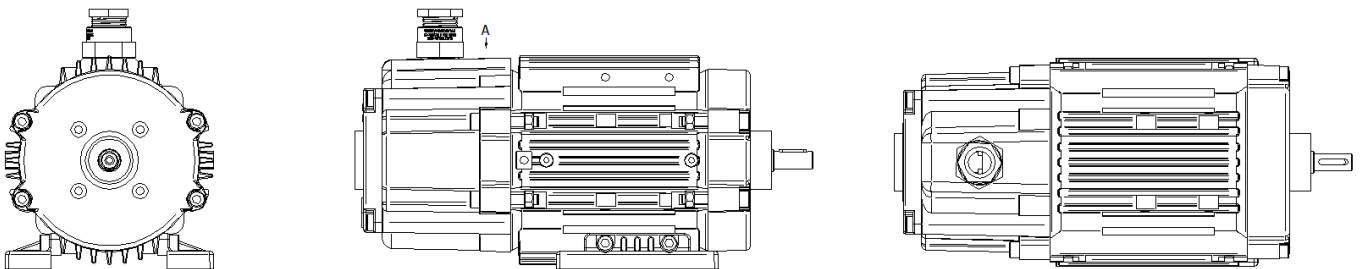

b. Back

With or without cable gland/ cable.

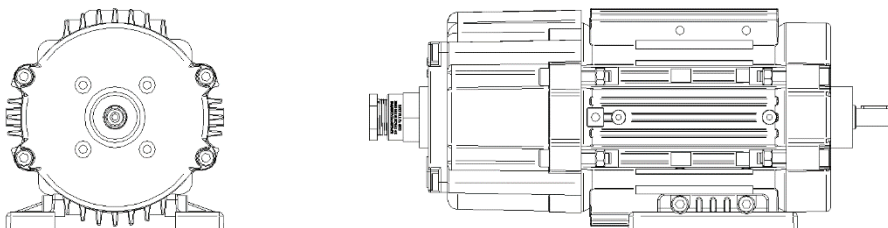

Possible cable output position for feet mounted version

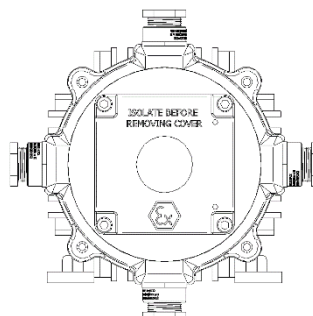

3.3 Cable entries and terminals

Motor version Ex 'd' must be provided with cable entries that comply with EN 60079-1.
 Motor version Ex 'de' must be provided with cable entries that comply with EN 60079-7.
 Motor version Ex t must be provided with cable entries that comply with EN 61241-1.

		Cable entries			Terminals
		Frame	Standard	On request	
Three phase version	Mains	56 - 90	1 x M20	1 x NPT 1/2"	M4
		100 - 112	1 x M25	1 x NPT 3/4"	M5
		132-160	2 x M32	2 x NPT 1"	M6
	Auxiliaries	56-160	1 x M20	1 x NPT 1/2"	See (1) and (2)
Version with increased terminal box A. B. C	-	56 - 112	Up to n.4 cable entries M20 o M25	Up to n.4 cable entries NPT 3/4" o NPT 1"	

When the motor is provided with a thermal protection and/or heaters these must have a separate cable entry and the connection shall be done as shown below (depending on the type of terminal box):

(1) Terminal box version Ex 'd'
 (Terminal board 6 pins)

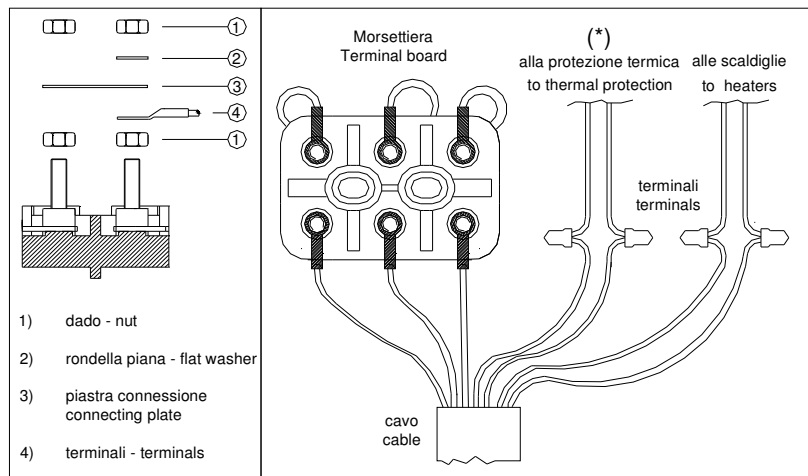

(2) Terminal box version Ex 'e'
 (Terminal board 6 pins increased safety 'e')

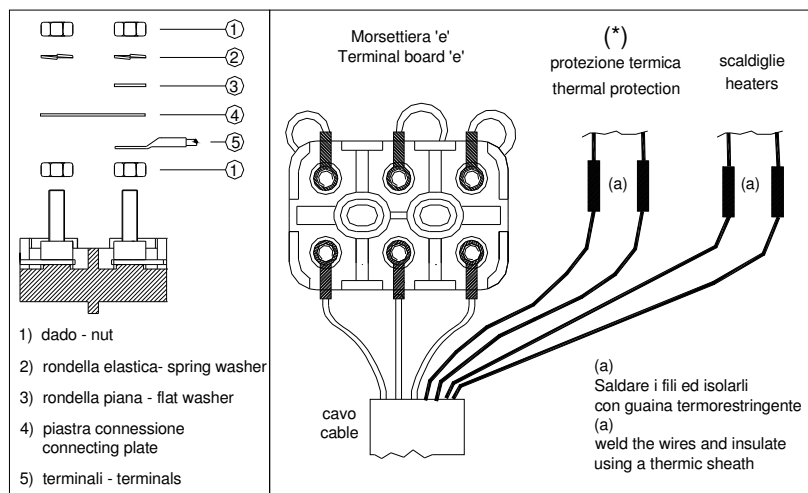



3.4 Connecting diagrams

Three phase 1 speed – Star and delta connection

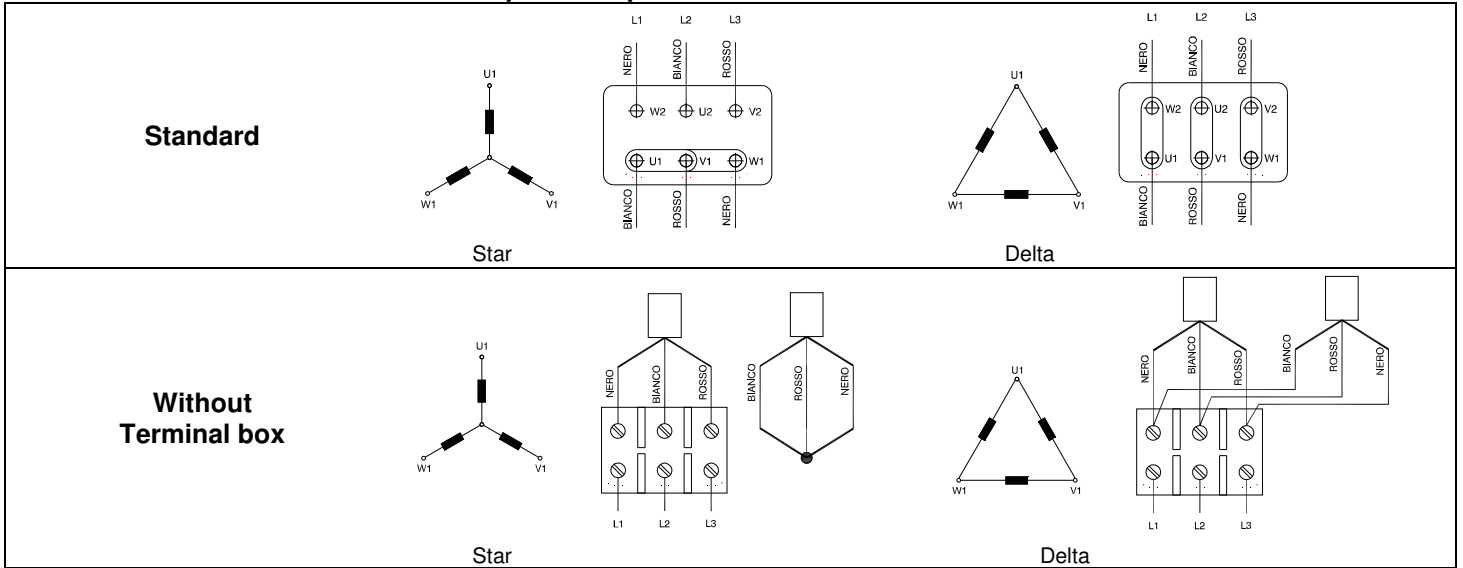

Three phase 2 speeds – Dahlander Connection - 2/4 - 4/8 poles

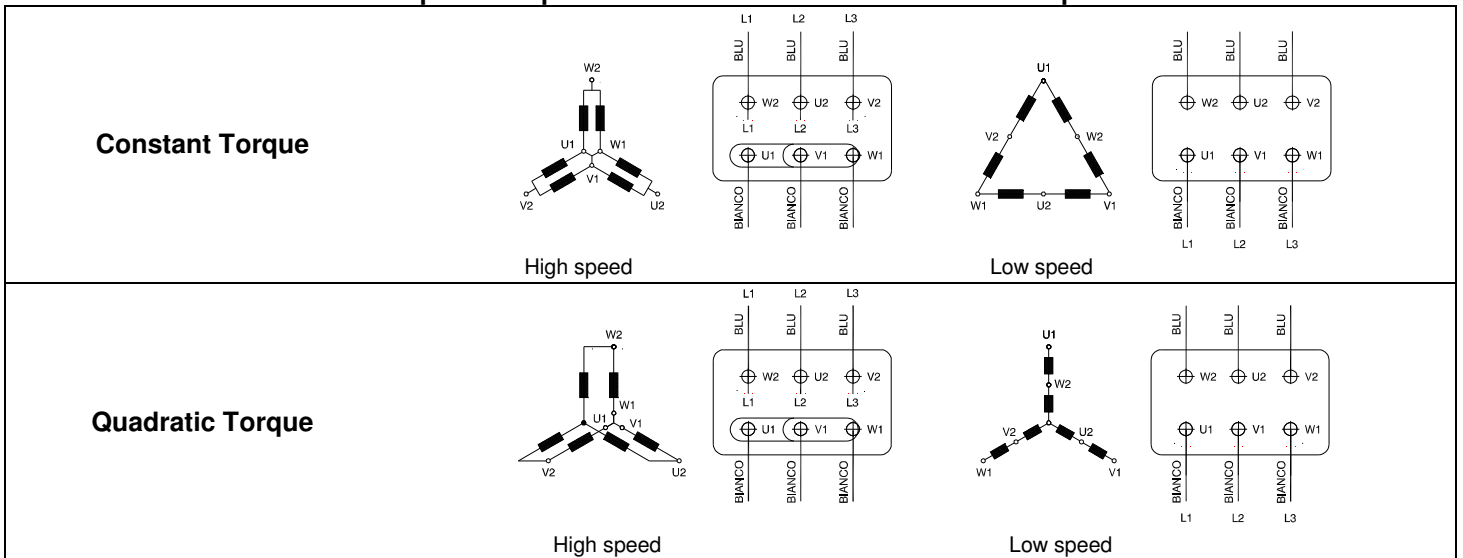

Three phase 2 speeds – 2 separate windings - 4/6 - 6/8 poles

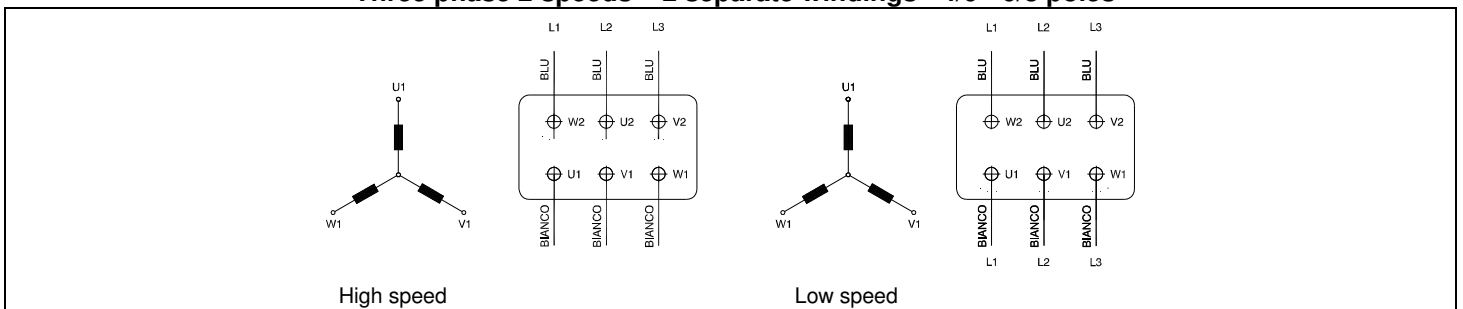

Single phase

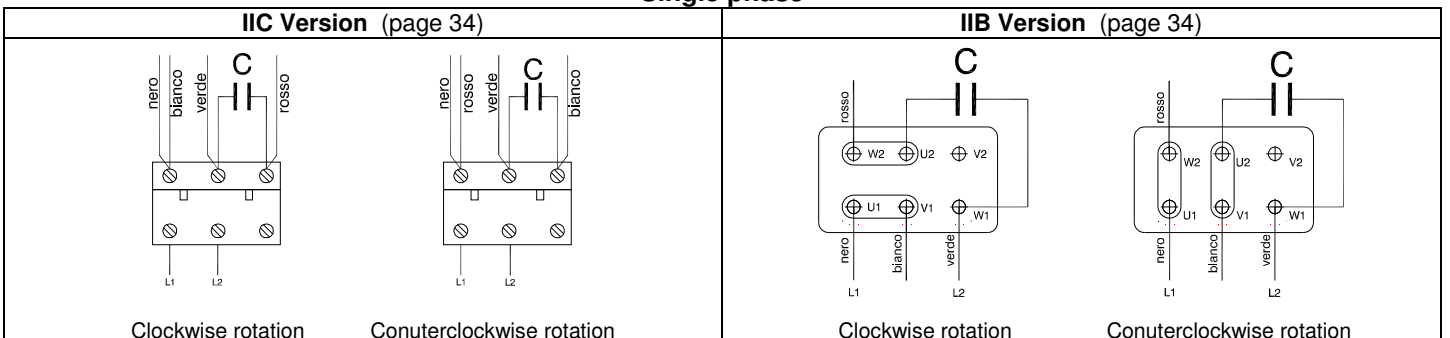



4. MECHANICAL CHARACTERISTIC

4.1 Mounting arrangements

RL motors can be made in the mounting arrangements as shown in the table.

Such motors are designed and manufactured with modular feet and flanges, so to ease the change of mounting arrangement and to optimize the warehouse management.

The basic mounting arrangements are shown in the standard EN 60034-7. Motors with mounting arrangements IM B3, IM B5, IM B14 can also be used in different mounting positions.

























IM B3 IM B6, IM B7, IM B8, IM V5 o IM V6.

IM B35 IM V15 o IM V36, IM 2051, IM 2061, IM 2071.

IM B34 IM 2111 o IM 2131, IM 2151, IM 2161, IM 2171.

IM B5 IM V1 o IM V3. (flange with passing holes).

IM B14 IM V18 o IM V19. (flange with threaded holes).

Basic mountings		Other mountings			
IM B3 IM 1001 	IM V5 IM 1011 	IM V6 IM 1031 	IM B6 IM 1051 	IM B7 IM 1061 	IM B8 IM 1071 
IM B35 IM 2001 	IM V15 IM 2011 	IM V36 IM 2031 	- IM 2051 	- IM 2061 	- IM 2071 
IM B34 IM 2101 	- IM 2111 	- IM 2131 	- IM 2151 	- IM 2161 	- IM 2171 
IM B5 IM 3001 	IM V1 IM 3011 	IM V3 IM 3031 			
IM B14 IM 3601 	IM V18 IM 3611 	IM V19 IM 3631 			



4.2 Materials

Materials of the main components.

Type of material

Shield frames flanges terminal box	Shaft	Rotor	Fan	Fan cover	Tie rods	Screw	Cable glands	Motor Plate
Aluminium	Steel 35S20	Die-cast Aluminium (squirrel cage)	Thermoplastic material or Aluminium	Zinc-plated steel	Steel 4.8	Steel 8.8	nickel-plated brass	Anodized aluminium or <i>on request</i> stainless steel

Bearings

The 2Z series bearings are lubricated for life and required not further lubrication. Nevertheless, we recommend in case of continuous running, long time stop, low temperature, radial and/or axial load, frequency inverter used, to control some time to time the ball bearings (40 000 hours for 4,6,8 pole motors and 20 000 hours for the 2 pole motors).

Motor		Bearing		Lubrication
Frame	Poles	Drive-end shield	Rear shield	
56	2 - 4 - 6 - 8	6201 2Z	6201 2Z	It doesn't need lubrication
63	2 - 4 - 6 - 8	6202 2Z	6202 2Z	It doesn't need lubrication
71	2 - 4 - 6 - 8	6202 2Z	6202 2Z	It doesn't need lubrication
80	2 - 4 - 6 - 8	6204 2Z	6204 2Z	It doesn't need lubrication
90	2 - 4 - 6 - 8	6205 2Z	6205 2Z	It doesn't need lubrication
100	2 - 4 - 6 - 8	6206 2Z	6206 2Z	It doesn't need lubrication
112	2 - 4 - 6 - 8	6306 2Z	6306 2Z	It doesn't need lubrication
132	2 - 4 - 6 - 8	6308 2Z	6308 2Z	It doesn't need lubrication
160	2 - 4 - 6 - 8	6309 2Z	6309 2Z	It doesn't need lubrication

Rotary shaft seals

Motors RL series can be equipped with seals so to guarantee an IP66 degree protection. In such a way the motor is protected from the income of dust and polluting agents.

IP65 or IP66 protection degree is furthermore necessary to warranty the protection type Ex t.

Motor		Rotary shaft seal (DIN 3760)	
Frame	Poles	Front	Rear
56	2 - 4 - 6 - 8	12x22x7A	12x22x7A
63	2 - 4 - 6 - 8	15x24x5A	15x24x5A
71	2 - 4 - 6 - 8	15x24x5A	15x24x5A
80	2 - 4 - 6 - 8	20x30x5A	20x30x5A
90	2 - 4 - 6 - 8	25x37x5A	25x37x5A
100	2 - 4 - 6 - 8	30x50x7A	30x50x7A
112	2 - 4 - 6 - 8	30x50x7A	30x50x7A
132	2 - 4 - 6 - 8	40x72x7A	40x72x7A
160	2 - 4 - 6 - 8	45x72x8A	45x72x8A



5. ELECTRICAL DATA

5.1 Three phase motors - 1 speed

The features of three phase motors for general purpose are as follows:

- Three phase asynchronous motor, squirrel cage rotor, self ventilated (IC411).
- Duty S1, Insulation class "F", IP55, 400V - 50 Hz.

Type	Δ	Y
56 – 112	230 V	400V
132 – 160	400 V	690 V
56-160 for INVERTER	230 V	400 V

- For temperature class T5 and T6 and ambient temperature see par 2.1

5.1.1 Motors for INVERTER duty

In case the motors are driven by **INVERTER** we have to point out some things:

- Motor must be equipped with PTC thermistor.
- Motor driven by inverter means not to have a perfect voltage and current sine wave with increase of losses and heating of the motor.
- Speed variation affects also the ventilation (in case of IC411).
- The stress on the bearings increases and they shall be checked more frequently; for this reason the operating period with a speed above 3600 rpm shall never exceed 10% of the complete working cycle.
- The **best connection** for motors driven by inverter is the **star connection 400V**.
- In case of **constant torque application and with frequency values above 60Hz** it is necessary to use a **delta connection**.

For all these reasons RAEL manufactures special motors for inverter duty so to minimize all the inconveniences described above.

These motors are electrically oversized so to minimize the electrical losses and also reduce the heating and are provided with thermistor PTC120°C for temperature class T4; for this reason the winding of the motor is made on an oversized stator and is fitted with phase-insulators (on request it is possible to have the version T5 with PTC90°C and T6 with PTC70°C).

In case of overheating it is possible to use the forced ventilation option (see page 15).

All the bearings mounted on RAEL motors have the best quality for motors (V2 type).

In this paragraph we will show the rating of the 1 speed 3-phase motors and the rating of the motors for inverter duty.

The data tables of the motors for inverter duty give an idea of power and current values and are reliable only in the case that the inverter used to drive the motor is an high quality and an high performance one.



Speed 3000 Rated data at 400V/50Hz – direct on line start																
Code	Type				P		rpm min ⁻¹	In 400 V Amp.	I _a /I _n	η%	Cos φ	M _n Nm	M _a /M _n	m Kg	Class T	Moment of inertia J 10 ⁻³ Kg.m ²
					kW	hp										
RL0042	RL	56	A	2	0,06	0,08	2730	0,5	4	43	0,4	0,2	3,5	3,5	T4/T5	0,09
RL0043	RL	56	A	2	0,09	0,12	2730	0,53	4	51,5	0,5	0,3	4,0	4	T4/T5	0,09
RL0044	RL	56	B	2	0,12	0,16	2800	0,56	4,5	57,3	0,54	0,35	4	4,5	T4/T5	0,1
RL0001	RL	63	A	2	0,12	0,16	2730	0,6	3,1	50	0,8	0,4	3,3	6,5	T4/T5	0,13
RL0002	RL	63	A	2	0,18	0,25	2760	0,7	3,6	60	0,8	0,6	3,8	6,5	T4/T5	0,13
RL0003	RL	63	B	2	0,25	0,34	2740	1	4,3	52	0,85	0,9	3,5	7	T4/T5	0,19
RL0004	RL	71	A	2	0,37	0,50	2770	1,2	4,8	70	0,8	1,3	3	7	T4/T5	0,36
RL0005	RL	71	B	2	0,55	0,75	2710	1,7	3,8	62	0,85	2,1	3	8	T4/T5	0,46
RL0006	RL	80	A	2	0,75	1,00	2820	2	5	70	0,88	2,6	2,4	10	T4/T5	0,76
RL0007	RL	80	B	2	1,10	1,50	2850	2,6	5,8	76	0,88	3,8	3	11	T4/T5	0,89
RL0008	RL	90	S	2	1,50	2,00	2800	3,6	5	74	0,86	5,2	2,9	16	T4/T5	1,37
RL0009	RL	90	L	2	2,20	3,00	2860	5	5,4	74	0,85	7,5	3	18	T4/T5	1,8
RL0032	RL	100	LA	2	3,00	4,00	2845	7	6	79	0,84	10,2	2,6	23	T4/T5	2,8
RL0033	RL	112	M	2	4,00	5,50	2880	8,9	6,4	85	0,89	13,4	2,3	30	T4/T5	5,2
RL 0080	RL	112	L	2	5,50	7,50	2920	12,2	6,5	84	0,85	18	2,5	40	T4/T5	6
RL0049	RL	132	SA	2	5,50	7,50	2870	12,4	6,7	84	0,82	18,3	2,6	54	T4/T5	10,63
RL0050	RL	132	SB	2	7,50	10,00	2880	15,7	6,9	85	0,90	24,7	2,9	59	T4/T5	13,83
RL0051	RL	132	MB	2	9,00	12,00	2930	18,5	6,9	87	0,89	30,5	2,9	65	T4/T5	17,31
RL0052	RL	132	ML	2	11,00	15,00	2930	22,0	6,8	88,5	0,89	36	2,8	71	T4/T5	17,31
RL0053	RL	160	MA	2	11,00	15,00	2915	23,5	7,9	81,5	0,89	36	2,8	98	T4/T5	40
RL0054	RL	160	MB	2	15,00	20,00	2910	30,0	8,4	84	0,91	49	3,1	110	T4/T5	51,75
RL0055	RL	160	L	2	18,50	25,00	2925	36,3	8,0	87,0	0,90	60	3,1	115	T4/T5	64
RL0073	RL	160	L	2	22,00	30,00	2923	40	7,5	89	0,91	71,3	2,8	130	T4/T5	81

All motors are certified as follows :

TUV IT 13 ATEX 038X version IIB (T.amb. -40;+60 °C for T4 -T5-T6)

TUV IT 13 ATEX 039X version IIC (T.amb. -20;+60 °C for T4 and -20,+50 for T5 and T.amb. -20;+40 °C for T6)

TUV IT 12 ATEX 070X version IIC (T.amb. -40;+60 °C for T4 -T5-T6) valid for TUBE MOTORS

Euro multi voltage 50/60 Hz

1 Speed 3000 Motors for INVERTER - Rated data at 400V/50Hz																
Code	Type				P		rpm min ⁻¹	In 400 V Amp.	I _a /I _n	η%	Cos φ	M _n Nm	M _a /M _n	m Kg	Class T	Moment of inertia J 10 ⁻³ Kg.m ²
					kW	hp										
RL0642-I	RL	56	A	2	0,06	0,08	2730	0,5	4,0	43	0,40	0,2	3,5	3,5	T4	0,1
RL0643-I	RL	56	A	2	0,09	0,12	2730	0,53	4	51,5	0,5	0,3	4,0	4	T4	0,1
RL0644-I	RL	56	B	2	0,12	0,16	2750	0,56	4,5	57,3	0,54	0,35	4	4,5	T4	0,12
RL0601-I	RL	63	A	2	0,12	0,16	2730	0,6	3,1	50	0,8	0,4	3,3	6,5	T4	0,16
RL0602-I	RL	63	A	2	0,18	0,25	2760	0,7	3,6	60	0,8	0,6	3,8	6,5	T4	0,16
RL0603-I	RL	63	B	2	0,25	0,34	2740	1	4,3	52	0,85	0,9	3,5	7	T4	0,23
RL0604-I	RL	71	A	2	0,37	0,50	2770	1,2	4,8	70	0,8	1,3	3	7	T4	0,45
RL0605-I	RL	71	B	2	0,55	0,75	2710	1,7	3,8	62	0,85	2,1	3	8	T4	0,5
RL0606-I	RL	80	A	2	0,75	1,00	2820	2	5	70	0,88	2,6	2,4	10	T4	0,9
RL0607-I	RL	80	B	2	1,10	1,50	2850	2,6	5,8	76	0,88	3,8	3	11	T4	1
RL0608-I	RL	90	S	2	1,50	2,00	2800	3,6	5	74	0,86	5,2	2,9	16	T4	1,4
RL0609-I	RL	90	L	2	2,20	3,00	2860	5	5,4	74	0,85	7,5	3	18	T4	1,9
RL0632-I	RL	100	LA	2	3,00	4,00	2845	7	6	79	0,84	10,2	2,6	23	T4	3
RL0633-I	RL	112	M	2	4,00	5,50	2880	8,9	6,4	85	0,89	13,4	2,3	30	T4	5,8
RL0649-I	RL	132	SA	2	5,50	7,50	2870	12,4	6,7	84	0,82	18,3	2,6	54	T4	11
RL0650-I	RL	132	SB	2	7,50	10,00	2880	15,7	6,9	85	0,90	24,7	2,9	59	T4	14,2
RL0651-I	RL	132	MB	2	9,00	12,00	2930	18,5	6,9	87	0,89	30,5	2,9	65	T4	18
RL0652-I	RL	132	ML	2	11,00	15,00	2930	22,0	6,8	88,5	0,89	36	2,8	71	T4	18
RL0653-I	RL	160	MA	2	11,00	15,00	2915	23,5	7,9	81,5	0,89	36	2,8	98	T4	41
RL0654-I	RL	160	MB	2	15,00	20,00	2910	30,0	8,4	84	0,91	49	3,1	110	T4	53
RL0655-I	RL	160	L	2	18,50	25,00	2925	36,3	8,0	87,0	0,90	60	3,1	115	T4	65

All motors are certified as follows :

TUV IT 13 ATEX 038X version IIB (T.amb. -40;+60 °C for T4)

TUV IT 13 ATEX 039X version IIC (T.amb. -20;+60 °C for T4)

Range of frequency 5÷87 Hz



1 Speed 1500 Rated data at 400V/50Hz – direct on line start																
Code	Type				P		rpm min ⁻¹	In 400 V Amp.	I _a /I _n	η %	Cos φ	M _n Nm	M _a /M _n	m Kg	T Class	Moment of inertia J 10 ⁻³ Kg.m ²
					kW	hp										
RL0045	RL	56	A	4	0,06	0,08	1360	0,4	3,5	64	0,68	0,4	4	4	T4/T5	0,14
RL0046	RL	56	B	4	0,09	0,12	1360	0,45	3	66,5	0,665	0,6	3,5	4,5	T4/T5	0,14
RL0010	RL	63	A	4	0,12	0,16	1400	0,74	3,3	51	0,6	0,9	3	6	T4/T5	0,25
RL0011	RL	63	B	4	0,18	0,25	1400	0,84	3,5	65	0,63	1,3	2,2	6,5	T4/T5	0,27
RL0012	RL	71	A	4	0,25	0,34	1370	1,2	3	50	0,73	1,8	2,2	6,5	T4/T5	0,63
RL0013	RL	71	B	4	0,37	0,50	1370	1,5	3,4	57	0,74	2,6	2,4	7,5	T4/T5	0,76
RL0014	RL	80	A	4	0,55	0,75	1410	1,7	4,4	63	0,8	3,8	2,2	10	T4/T5	1,58
RL0015	RL	80	B	4	0,75	1,00	1410	2,2	4,9	67	0,8	5,2	1,9	12	T4/T5	2
RL 0082	RL	80	B	4	1,00	1,5	1425	3,2	4,9	70	0,65	6,9	2	13	T4/T5	2,2
RL0016	RL	90	S	4	1,10	1,50	1410	3	4,2	73	0,77	7,7	2,3	16	T4/T5	2,5
RL0017	RL	90	L	4	1,50	2,00	1400	4	5	72	0,8	10,4	3	17,5	T4/T5	3,13
RL0034	RL	100	LA	4	2,20	3,00	1410	5,2	6	80	0,84	15,1	2,5	23	T4/T5	4,5
RL0035	RL	100	LB	4	3,00	4,00	1440	7,1	6	82	0,87	20,1	2,6	25	T4/T5	5,58
RL0036	RL	112	M	4	4,00	5,50	1450	9,1	5,5	84	0,82	26,8	2,1	35	T4/T5	12,2
RL 0081	RL	112	L	4	5,50	7,50	1440	11,9	5,7	85	0,8	36,3	2,5	38	T4/T5	14,2
RL0056	RL	132	SB	4	5,50	7,50	1440	12	6,1	85	0,82	36	2,4	60	T4/T5	22,4
RL0057	RL	132	MB	4	7,50	10,00	1448	16,3	6,6	87	0,84	49,5	2,4	66	T4/T5	29,25
RL0058	RL	132	ML	4	9,00	12,00	1460	19,5	6,7	84	0,86	58	2,5	71	T4/T5	37,25
RL0059	RL	160	MB	4	11,00	15,00	1460	23,8	5,5	88	0,85	72	2,6	105	T4/T5	81,25
RL0060	RL	160	L	4	15,00	20,00	1450	30,6	5,8	87	0,83	97,1	2,6	115	T4/T5	105,75
RL 0071	RL	160	ML	4	18,50	25,00	1450	34,9	5,8	90	0,85	120,0	3,0	120	T4/T5	120
RL 0072	RL	160	LL	4	22,00	30,00	1450	44,0	5,9	90	0,85	142,9	2,80	140,0	T4/T5	125

All motors are certified as follows: :

TUV IT 13 ATEX 038X version IIB (T.amb. -40;+60 °C for T4 -T5-T6)

TUV IT 13 ATEX 039X version IIC (T.amb. -20;+60 °C for T4 and -20,+50 for T5, and T.amb. -20;+40 °C for T6)

TUV IT 12 ATEX 070X version IIC (T.amb. -40;+60 °C for T4 -T5-T6) valid for TUBE MOTORS

Euro multi voltage 50/60 Hz

1 speed 1500 rpm - Motors for inverter -Rated data at 400V /50Hz																
Code	Type				P		rpm min ⁻¹	In 400 V Amp.	I _a /I _n	η%	Cos φ	M _n Nm	M _a /M _n	m Kg	Classe T Class	Moment of inertia J 10 ⁻³ Kg.m ²
					kW	hp										
RL0645-I	RL	56	A	4	0,06	0,08	1360	0,4	3,5	64	0,68	0,4	4	4	T4	0,15
RL0646-I	RL	56	B	4	0,09	0,12	1360	0,45	3	66,5	0,665	0,6	3,5	4,5	T4	0,15
RL0610-I	RL	63	A	4	0,12	0,16	1400	0,74	3,3	51	0,6	0,9	3	6	T4	0,29
RL0611-I	RL	63	B	4	0,18	0,25	1400	0,84	3,5	65	0,63	1,3	2,2	6,5	T4	0,3
RL0612-I	RL	71	A	4	0,25	0,34	1370	1,2	3	50	0,73	1,8	2,2	6,5	T4	0,75
RL0613-I	RL	71	B	4	0,37	0,50	1370	1,5	3,4	57	0,74	2,6	2,4	7,5	T4	0,8
RL0614-I	RL	80	A	4	0,55	0,75	1410	1,7	4,4	63	0,8	3,8	2,2	10	T4	1,7
RL0615-I	RL	80	B	4	0,75	1,00	1410	2,2	4,9	67	0,8	5,2	1,9	12	T4	2,2
RL0616-I	RL	90	S	4	1,10	1,50	1410	3	4,2	73	0,77	7,7	2,3	16	T4	2,9
RL0017-I	RL	90	L	4	1,50	2,00	1400	4	5	72	0,8	10,4	3	17,5	T4	3,4
RL0634-I	RL	100	LA	4	2,20	3,00	1410	5,2	6	80	0,84	15,1	2,5	23	T4	5
RL0635-I	RL	100	LB	4	3,00	4,00	1440	7,1	6	82	0,87	20,1	2,6	25	T4	6,1
RL0636-I	RL	112	M	4	4,00	5,50	1450	9,1	5,5	84	0,82	26,8	2,1	35	T4	13
RL0656-I	RL	132	SB	4	5,50	7,50	1440	12	6,1	85	0,82	36	2,4	60	T4	23
RL0657-I	RL	132	MB	4	7,50	10,00	1448	16,3	6,6	87	0,84	49,5	2,4	66	T4	30,5
RL0658-I	RL	132	ML	4	9,00	12,00	1460	19,5	6,7	84	0,86	58	2,5	71	T4	38,1
RL0659-I	RL	160	MB	4	11,00	15,00	1460	23,8	5,5	88	0,85	72	2,6	105	T4	82
RL0660-I	RL	160	L	4	15,00	20,00	1450	30,6	5,8	87	0,83	97,1	2,6	115	T4	107

All motors are certified as follows: :

TUV IT 13 ATEX 038X version IIB (T.amb. -40;+60 °C for T4)

TUV IT 13 ATEX 039X version IIC (T.amb. -20;+60 °C for T4)

Range of frequency 5÷87 Hz

1 speed 1000 rpm Rated data at 400V / 50Hz - direct on line start

Code	Type			P		rpm min ⁻¹	In 400 V Amp.	I _a /I _n	η%	Cos φ	M _n Nm	M _a /M _n	m Kg	Classe T Class	Moment of inertia J 10 ⁻³ Kg.m ²	
				kW	Hp											
RL0018	RL	63	B	6	0,12	0,16	900	0.8	2.6	43	0.7	1,3	2.6	7	T4/T5	0,3
RL0019	RL	71	A	6	0,18	0,25	900	1	2.8	46	0.7	2,0	2.4	7	T4/T5	0,6
RL0020	RL	71	B	6	0,25	0,34	910	1.4	2.9	50	0.6	2,7	3.1	8	T4/T5	0,9
RL0021	RL	80	A	6	0,37	0,50	935	1.6	3.9	62	0.65	3,8	2.6	10	T4/T5	1,97
RL0022	RL	80	B	6	0,55	0,75	930	2	3.5	64	0.7	5,8	2.8	12	T4/T5	2,47
RL0023	RL	90	S	6	0,75	1,00	930	2.4	3.5	71	0.7	7,9	2.3	16	T4/T5	3,18
RL0024	RL	90	L	6	1,10	1,50	910	3.4	3.7	67	0.75	11,6	2.3	17.5	T4/T5	4,78
RL0037	RL	100	LB	6	1,50	2,00	940	4.4	3.8	80	0,75	15,2	1.7	25	T4/T5	6,73
RL0038	RL	112	M	6	2,20	3,00	940	5.4	4.7	81,5	0,8	22,4	1.8	35	T4/T5	14,18
RL0061	RL	132	SB	6	3,00	4,00	945	8,5	4,5	86	0,75	30,3	1,7	62	T4/T5	23,53
RL0062	RL	132	MB	6	4,00	5,50	950	10,9	4,5	82,4	0,77	39,0	1,8	65	T4/T5	29,5
RL0063	RL	132	ML	6	5,50	7,50	950	14,0	4,6	81	0,8	55,0	1,8	71	T4/T5	37,75
RL0064	RL	160	MB	6	7,50	10,00	965	16,4	4,5	85	0,86	75,6	1,8	106	T4/T5	81,25
RL0065	RL	160	L	6	11,00	15,00	955	23,3	4,6	85	0,86	110	1,8	118	T4/T5	105,75

All motors are certified as follows: :

TUV IT 13 ATEX 038X version IIB (T.amb. -40;+60 °C for T4- T5-T6)

TUV IT 13 ATEX 039X version IIC (T.amb. -20;+60 °C for T4 and -20,+50 for T5 and Tamb. -20;+40 °C for T6)

TUV IT 12 ATEX 070X version IIC (T.amb. -40;+60 °C for T4 -T5-T6) valid for TUBE MOTORS

Euro multi voltage 50/60 Hz

1 speed 1000 rpm - Motors for inverter -Rated data at 400V /50Hz

Code	Type			P		rpm min ⁻¹	In 400 V Amp.	I _a /I _n	η%	Cos φ	M _n Nm	M _a /M _n	m Kg	Classe T Class	Moment of inertia J 10 ⁻³ Kg.m ²	
				kW	Hp											
RL0618-I	RL	63	B	6	0,12	0,16	900	0.8	2.6	43	0.7	1,3	2.6	7	T4	0,35
RL0619-I	RL	71	A	6	0,18	0,25	900	1	2.8	46	0.7	2,0	2.4	7	T4	0,68
RL0620-I	RL	71	B	6	0,25	0,34	910	1.4	2.9	50	0.6	2,7	3.1	8	T4	1,1
RL0621-I	RL	80	A	6	0,37	0,50	935	1.6	3.9	62	0.65	3,8	2.6	10	T4	2,1
RL0622-I	RL	80	B	6	0,55	0,75	930	2	3.5	64	0.7	5,8	2.8	12	T4	2,8
RL0623-I	RL	90	S	6	0,75	1,00	930	2.4	3.5	71	0.7	7,9	2.3	16	T4	3,4
RL0624-I	RL	90	L	6	1,10	1,50	910	3.4	3.7	67	0.75	11,6	2.3	17.5	T4	5
RL0637-I	RL	100	LB	6	1,50	2,00	940	4.4	3.8	80	0,75	15,2	1.7	25	T4	7,1
RL0638-I	RL	112	M	6	2,20	3,00	940	5.4	4.7	81,5	0,8	22,4	1.8	35	T4	15
RL0661-I	RL	132	SB	6	3,00	4,00	945	8,5	4,5	86	0,75	30,3	1,7	62	T4	24
RL0662-I	RL	132	MB	6	4,00	5,50	950	10,9	4,5	82,4	0,77	39,0	1,8	65	T4	30
RL0663-I	RL	132	ML	6	5,50	7,50	950	14,0	4,6	81	0,8	55,0	1,8	71	T4	38
RL0664-I	RL	160	MB	6	7,50	10,00	965	16,4	4,5	85	0,86	75,6	1,8	106	T4	82
RL0665-I	RL	160	L	6	11,00	15,00	955	23,3	4,6	85	0,86	110	1,8	118	T4	106

All motors are certified as follows: :

TUV IT 13 ATEX 038X version IIB (T.amb. -40;+60 °C for T4)

TUV IT 13 ATEX 039X version IIC (T.amb. -20;+60 °C for T4)

Range of frequency 5-87 Hz



1 speed 750 rpm Rated data at 400V /50Hz -direct on line start																
Code	Type			P		rpm min ⁻¹	In 400 V Amp.	I _a /I _n	η %	Cos φ	M _n Nm	M _a /M _n	m Kg	Classe T Class	Moment of inertia J10 ⁻³ Kg.m ²	
				kW	CV											
RL0025	RL	63	B	8	0,06	0,08	660	0.6	2.3	34	0.63	0,9	2.8	7	T4/T5	0,8
RL0026	RL	71	A	8	0,09	0,12	660	0.75	2.2	38	0.63	1,3	2.7	7	T4/T5	0,9
RL0027	RL	71	B	8	0,12	0,16	640	0.85	2	39	0.7	1,8	2.3	8	T4/T5	0,9
RL0028	RL	80	A	8	0,18	0,25	690	1.15	2.8	49	0.6	2,5	2.7	10	T4/T5	1,2
RL0029	RL	80	B	8	0,25	0,34	700	1.4	2.9	55	0.55	3,6	2.8	12	T4/T5	1,97
RL0030	RL	90	S	8	0,37	0,50	680	1.5	3	60	0.67	5,2	1.6	16	T4/T5	3,18
RL0031	RL	90	L	8	0,55	0,75	690	2.1	3	65	0.65	7,7	2.4	17.5	T4/T5	4,78
RL0039	RL	100	LA	8	0,75	1,00	700	3.1	3.4	65	0,65	10	2.3	23	T4/T5	6,72
RL0040	RL	100	LB	8	1,10	1,50	690	4.1	3.7	72,3	0,73	15,6	1.8	25	T4/T5	15,93
RL0041	RL	112	M	8	1,50	2,00	705	4.8	4.1	78,7	0,64	20,2	1.9	35	T4/T5	16,7
RL0066	RL	132	SB	8	2,20	3,00	705	6,9	3,8	82	0,75	30,2	1,8	56	T4/T5	29,5
RL0067	RL	132	MB	8	3,00	4,00	715	8,7	4	83,5	0,74	40,0	1,9	61	T4/T5	37,75
RL0068	RL	132	ML	8	4,00	5,50	710	11,2	4,1	82	0,78	52,0	1,9	97	T4/T5	89,5
RL0069	RL	160	MB	8	5,50	7,50	715	14,4	4	86	0,755	72,5	2,1	106	T4/T5	119,5
RL0070	RL	160	L	8	7,50	10,00	720	17,6	4,2	86	0,79	99,8	2,3	118	T4/T5	150,25

All motors are certified as follows :

TUV IT 13 ATEX 038X version IIB (T.amb. -40;+60 °C for T4 -T5-T6)

TUV IT 13 ATEX 039X version IIC (T.amb. -20;+60 °C for T4 and -20,+50 for T5 and Tamb. -20;+40 °C for T6)

TUV IT 12 ATEX 070X version IIC (T.amb. -40;+60 °C for T4 -T5-T6) valid for TUBE MOTORS

Euro multi voltage 50/60 Hz

1 speed 750 rpm -Motors for inverter -Rated data at 400V /50Hz																
Code	Type			P		rpm min ⁻¹	In 400 V Amp.	I _a /I _n	η %	Cos φ	M _n Nm	M _a /M _n	m Kg	Classe T Class	Moment of inertia J10 ⁻³ Kg.m ²	
				kW	CV											
RL0625-I	RL	63	B	8	0,06	0,08	660	0.6	2.3	34	0.63	0,9	2.8	7	T4	0,9
RL0626-I	RL	71	A	8	0,09	0,12	660	0.75	2.2	38	0.63	1,3	2.7	7	T4	1
RL0627-I	RL	71	B	8	0,12	0,16	640	0.85	2	39	0.7	1,8	2.3	8	T4	1,2
RL0628-I	RL	80	A	8	0,18	0,25	690	1.15	2.8	49	0.6	2,5	2.7	10	T4	1,4
RL0629-I	RL	80	B	8	0,25	0,34	700	1.4	2.9	55	0.55	3,6	2.8	12	T4	2,1
RL0630-I	RL	90	S	8	0,37	0,50	680	1.5	3	60	0.67	5,2	1.6	16	T4	3,4
RL0631-I	RL	90	L	8	0,55	0,75	690	2.1	3	65	0.65	7,7	2.4	17.5	T4	5
RL0639-I	RL	100	LA	8	0,75	1,00	700	3.1	3.4	65	0,65	10	2.3	23	T4	7
RL0640-I	RL	100	LB	8	1,10	1,50	690	4.1	3.7	72,3	0,73	15,6	1.8	25	T4	16,1
RL0641-I	RL	112	M	8	1,50	2,00	705	4.8	4.1	78,7	0,64	20,2	1.9	35	T4	17
RL0666-I	RL	132	SB	8	2,20	3,00	705	6,9	3,8	82	0,75	30,2	1,8	56	T4	30,4
RL0667-I	RL	132	MB	8	3,00	4,00	715	8,7	4	83,5	0,74	40,0	1,9	61	T4	38
RL0668-I	RL	132	ML	8	4,00	5,50	710	11,2	4,1	82	0,78	52,0	1,9	97	T4	90
RL0669-I	RL	160	MB	8	5,50	7,50	715	14,4	4	86	0,755	72,5	2,1	106	T4	120,5
RL0670-I	RL	160	L	8	7,50	10,00	720	17,6	4,2	86	0,79	99,8	2,3	118	T4	152

All motors are certified as follows :

TUV IT 13 ATEX 038X version IIB (T.amb. -40;+60 °C for T4)

TUV IT 13 ATEX 039X version IIC (T.amb. -20;+60 °C for T4)

Range of frequency 5÷87 Hz



5.2 Three-phase Motors 2 speed – Constant Torque (for general purpose)

- Three phase asynchronous motor, squirrel cage rotor, self ventilated (IC411).
- Duty S1, Insulation class "F", IP55, 400V- 50 Hz.

Connections	Poles	Connections	High Speed	Low Speed
	2/4 – 4/8	(Dahlander)	YY 400 V	Δ 400V
	4/6 – 6/8	(2 Separate windings)	Y 400 V	Y 400V

- For ambient temperature see par 2.1

		2 speed 3000/1500		COSTANT TORQUE - Rated data at 400V 50Hz												
Code	Type		Poles	P kW	rpm min ⁻¹	In 400 V Amp.	I _a /I _n	η%	Cosφ	M _n Nm	M _a /M _n	m Kg	Class T	Moment of inertia J 10 ⁻³ Kg.m ²		
RL4001	RL 2CT	63	B	2/4	0,25	2800	1	3,5	52	0,7	0,9	1,7	6,5	T4	0,2	
					0,18	1380	88	3	58	0,66	1,3	1,7				
RL4002	RL 2CT	71	A	2/4	0,30	2800	1,35	3,2	53	0,71	1,1	1,7	6,5	T4	0,6	
					0,20	1400	1,05	3	57	0,66	1,4	1,5				
RL4003	RL 2CT	71	B	2/4	0,45	2805	1,72	3,8	60	0,7	1,6	1,8	7,5	T4	0,9	
					0,30	1400	1,2	3,6	68	0,62	2,1	1,8				
RL4004	RL 2CT	80	A	2/4	0,55	2820	1,9	4,1	67	0,76	1,9	1,7	10	T4	0,9	
					0,37	1390	1,7	3,9	68	0,625	2,6	1,7				
RL4005	RL 2CT	80	B	2/4	0,75	2830	2,3	4,4	72	0,81	2,6	1,8	12	T4	1,3	
					0,55	1400	2,1	4,1	67	0,71	3,9	1,8				
RL4006	RL 2CT	90	S	2/4	1,25	2830	3,2	5,4	73	0,82	4,4	2,1	16	T4	2	
					0,90	1405	2,8	4,6	69	0,72	6,4	1,9				
RL4007	RL 2CT	90	L	2/4	1,60	2820	4,05	4,2	70	0,81	5,6	2,1	17,5	T4	2,6	
					1,20	1405	3,3	3,5	69	0,76	8,5	2				
RL4008	RL 2CT	100	LA	2/4	2,35	2820	5,4	6,4	77	0,85	8,3	2,4	23	T4	4,3	
					1,85	1420	4,6	5,5	75	0,79	13	2,1				
RL4009	RL 2CT	100	LB	2/4	3,00	2840	6,95	7	77	0,84	10,5	2,2	25	T4	5,3	
					2,40	1425	5,35	6,1	77	0,85	16,8	2				
RL4010	RL 2CT	112	M	2/4	4,00	2890	9	7,1	77	0,88	13,8	2,2	35	T4	10,3	
					3,30	1430	7,5	6,2	78	0,87	23	2,2				
RL4036	RL 2CT	132	S	2/4	5,90	2850	13	7,1	84	0,85	19,5	2,2	60	T4	15	
					4,80	1440	10,4	6,3	85	0,87	32,0	2,1				
RL4037	RL 2CT	132	MB	2/4	7,50	2880	14,8	7,3	87	0,91	25,0	2,1	66	T4	17,8	
					5,50	1450	12	6,5	87	0,84	44,0	2,1				
RL4038	RL 2CT	132	L	2/4	8,00	2930	15,9	7,4	87	0,89	30,5	2,2	70,5	T4	21,6	
					6,00	1460	13	6,2	85	0,86	50,0	2,1				
RL4039	RL 2CT	160	M	2/4	11,00	2915	23	7,2	82	0,89	36,0	2,2	105	T4	62,7	
					8,80	1460	18	6,4	88	0,85	58,5	2,2				
RL4040	RL 2CT	160	L	2/4	15,00	2910	29,3	7,4	84	0,91	49,0	2,5	115	T4	80,1	
					12,00	1450	24,7	6,5	87	0,84	79,0	2,4				

All motors are certified as follows: :

TUV IT 13 ATEX 038X version IIB (T.amb. -40;+60 °C for T4 and T5)

TUV IT 13 ATEX 039X version IIC (T.amb. -20;+60 °C for T4 and -20,+50 for T5)



2 speed 1500/750 COSTANT TORQUE - Rated data at 400V 50Hz																
Code	Type	Poles	P kW	rpm min ⁻¹	In 400 V Amp.	I _a /I _n	η%	Cosφ	M _n Nm	M _a /M _n	m Kg	Class T	Moment of inertia J 10 ⁻³ Kg.m ²			
RL4011	RL 2CT	71 A	0,18	1380	0,82	3,5	68	0,62	1,3	2,2	6,5	T4	0,07			
			0,09	660	0,65	2,2	40	0,72	1,4	2,7						
RL4012	RL 2CT	71 B	0,25	1380	0,88	3	70	0,75	1,5	2,2	8	T4	1			
			0,12	660	0,78	2	42	0,71	1,5	2,3						
RL4013	RL 2CT	80 A	0,37	1400	1,2	3,4	71	0,75	2,2	2,4	10	T4	2,2			
			0,18	670	0,97	2,8	50	0,67	2,3	2,7						
RL4014	RL 2CT	80 B	0,55	1400	1,63	4,4	75	0,74	3,1	2,2	12	T4	2,7			
			0,25	670	2,17	2,9	54	0,69	2,9	2,8						
RL4015	RL 2CT	90 S	0,75	1405	2,05	4,9	71	0,77	4,5	1,9	16	T4	3,4			
			0,37	675	1,43	3	62	0,7	4,4	1,6						
RL4016	RL 2CT	90 L	1,00	1405	2,7	4,2	77	0,75	6,9	2,3	18	T4	4,9			
			0,55	675	1,9	3	67	0,7	6,8	2,4						
RL4017	RL 2CT	100 LA	1,30	1420	3,7	4,5	79	0,77	9,1	3	23	T4	8,8			
			0,70	700	2,6	4,9	70	0,68	8,9	1,9						
RL4018	RL 2CT	100 LB	1,80	1430	4,5	5	80	0,81	11,5	2,5	25	T4	8,8			
			0,90	690	3,1	3,7	72	0,74	12	1,8						
RL4019	RL 2CT	112 M	2,50	1450	5,5	5,5	81	0,85	17,2	2,1	35	T4	17,2			
			1,25	705	4,2	4,1	78	0,65	16,9	1,9						
RL4041	RL 2CT	132 S	3,30	1445	7,8	4,9	83	0,85	22,0	1,6	56	T4	32,3			
			1,85	705	5,4	4,1	82	0,75	25,0	1,6						
RL4042	RL 2CT	132 MB	4,80	1430	11,0	5,2	85	0,82	32,0	1,7	64	T4	50,6			
			2,40	710	6,6	4,3	82	0,76	33,0	1,7						
RL4043	RL 2CT	132 L	5,50	1440	12,4	5,5	85	0,82	36,0	1,8	71	T4	50,6			
			3,00	715	8,0	4,5	84	0,74	39,7	1,8						
RL4044	RL 2CT	160 M	7,50	1450	18,1	87,0	0,84	49,00	1,9		106	T4	91,9			
			4,80	715	11,7	86,0	0,76	63,00	1,8							
RL4045	RL 2CT	160 L	10,00	1450	21,7	6,8	83	0,84	66,0	1,9	118	T4	121,8			
			6,60	720	13,8	5,6	86	0,87	88	1,9						

All motors are certified as follows: :

TUV IT 13 ATEX 038X version IIB (T.amb. -40;+60 °C for T4 and T5)

TUV IT 13 ATEX 039X version IIC (T.amb. -20;+60 °C for T4 and -20,+50 for T5)



		2 speed 1500/1000		COSTANT TORQUE - Rated data at 400V 50Hz												
Code		Type		Poles	P kW	rpm min ⁻¹	In 400 V Amp.	I _a /I _n	η%	Cosφ	M _n Nm	M _a /M _n	m Kg	Class T	Moment of inertia J 10 ⁻³ Kg.m ²	
RL4020	RL	2CT	71	B	4/6	0,20	1400	0,75	3,3	70	0,75	1,3	1,4	8	T4	1
						0,10	900	0,58	2,4	53	0,71	1,1	1,4			
RL4021	RL	2CT	80	A	4/6	0,40	1400	1,3	3,4	71	0,75	2,9	1,4	10	T4	2,7
						0,20	905	0,85	2,5	62	0,72	2,1	1,5			
RL4022	RL	2CT	80	B	4/6	0,50	1405	1,58	3,6	71	0,74	3,4	1,5	12	T4	2,7
						0,30	910	2,1	3,1	66	0,73	3,0	1,5			
RL4023	RL	2CT	90	S	4/6	0,65	1405	1,85	5,8	76	0,75	4,5	1,6	16	T4	3,4
						0,45	910	1,46	4,3	70	0,73	4,6	1,5			
RL4024	RL	2CT	90	L	4/6	0,95	1410	2,56	5,5	77	0,76	6,3	1,5	18	T4	4,9
						0,60	910	1,86	3,6	70	0,74	6,4	1,6			
RL4025	RL	2CT	100	LA	4/6	1,40	1415	3,7	5,7	81	0,73	9,4	1,8	23	T4	8,8
						0,90	910	2,9	4,1	74	0,74	9,3	1,7			
RL4026	RL	2CT	100	LB	4/6	1,85	1415	4,6	5,8	80	0,81	12,4	1,6	25	T4	8,8
						1,10	910	3,4	3,9	74	0,74	12,1	1,6			
RL4027	RL	2CT	112	M	4/6	2,4	1420	5,45	6,1	82	0,85	16,2	1,8	35	T4	17,2
						1,6	940	4,16	4,3	81	0,77	16,5	1,7			
RL4046	RL	2CT	132	S	4/6	3,00	1440	7,0	5,9	82	0,87	20,0	1,9	55	T4	32,3
						2,00	945	5,5	3,9	81	0,80	20,2	1,6			
RL4047	RL	2CT	132	MA	4/6	4,00	1450	9,4	6,1	84	0,82	26,3	2,0	60	T4	39,5
						2,60	940	6,8	4,5	84	0,77	25,9	1,8			
RL4048	RL	2CT	132	MB	4/6	4,40	1445	10,0	6,3	83	0,89	29,0	1,9	66	T4	50,6
						3,00	965	7,6	4,4	80	0,80	30,3	1,7			
RL4049	RL	2CT	132	L	4/6	5,15	1450	11,7	6,8	85	0,82	33,5	1,9	71	T4	50,6
						3,30	945	8,3	4,7	86	0,76	33,0	1,7			
RL4050	RL	2CT	160	M	4/6	6,60	1460	14,4	6,8	86	0,83	43,0	1,9	106	T4	91,9
						4,40	950	10,9	4,4	82	0,79	43,9	1,8			
RL4051	RL	2CT	160	L	4/6	8,80	1460	22,2	6,8	83	0,84	57,7	1,9	118	T4	121,8
						5,90	950	33,6	4,9	81	0,8	58	1,8			

All motors are certified as follows: :

TUV IT 13 ATEX 038X version IIB (T.amb. -40;+60 °C for T4 and T5)

TUV IT 13 ATEX 039X version IIC (T.amb. -20;+60 °C for T4 and -20,+50 for T5)



2 speed 1000/750						COSTANT TORQUE - Rated data at 400V 50Hz										
Code	Type		Poles			P kW	rpm min ⁻¹	In 400 V Amp.	I _a /I _n	η%	Cosφ	M _n Nm	M _a /M _n	m Kg	Class T	Moment of inertia J 10 ⁻³ Kg.m ²
RL4028	RL	2CT	71	B	6/8	0,12	900	0,73	2,4	50	0,71	1,3	1,4	8	T4	1
						0,08	690	0,64	2,2	49	0,61	1,1	1,3			
RL4029	RL	2CT	80	A	6/8	0,15	935	0,88	2,6	50	0,71	1,5	1,5	10	T4	2,7
						0,13	690	0,83	2,1	52	0,6	1,9	1,5			
RL4030	RL	2CT	80	B	6/8	0,25	930	1,2	3,2	52	0,72	2,7	1,5	12	T4	2,7
						0,15	685	1,02	2,2	49	0,6	2,2	1,4			
RL4031	RL	2CT	90	S	6/8	0,35	910	1,55	3,8	55	0,74	3,6	1,4	16	T4	3,4
						0,25	650	1,2	3,1	60	0,6	3,8	2,5			
RL4032	RL	2CT	90	L	6/8	0,60	935	2,2	3,8	60	0,76	6,1	1,5	18	T4	4,9
						0,30	685	1,55	3,4	61	0,6	4,3	1,6			
RL4033	RL	2CT	100	LA	6/8	0,80	920	2,85	4	65	0,77	8,2	1,5	23	T4	8,8
						0,55	700	2,4	3,6	68	0,63	7,4	1,6			
RL4034	RL	2CT	100	LB	6/8	1,00	930	3,4	4,1	67	0,75	10,5	1,6	25	T4	8,8
						0,65	700	2,7	3,7	68	0,66	8,8	1,6			
RL4035	RL	2CT	112	M	6/8	1,50	960	4,7	4	75	0,72	15,0	1,7	35	T4	17,2
						1,00	710	3,8	3,9	65	0,7	13,4	1,6			
RL4052	RL	2CT	132	S	6/8	1,85	960	6,2	4,1	74	0,71	18,4	1,6	60	T4	32,3
						1,30	720	5,1	4,0	68	0,65	17,5	1,8			
RL4053	RL	2CT	132	MB	6/8	2,55	965	7,9	4,2	74	0,73	25,1	1,8	66	T4	39,5
						1,85	720	6,9	4,1	69	0,67	24,6	1,8			
RL4054	RL	2CT	132	L	6/8	3,00	980	8,3	4,2	80	0,75	29,5	1,8	71	T4	50,6
						2,00	735	6,9	4,1	74	0,65	26,3	1,9			
RL4055	RL	2CT	160	M	6/8	4,00	980	10,4	4,3	82	0,75	39,3	1,9	106	T4	91,9
						2,80	725	8,5	4,2	78	0,70	37,2	1,9			
RL4056	RL	2CT	160	L	6/8	5,50	985	13,9	4,3	84	0,74	53,5	1,9	118	T4	121,18
						4,00	730	10,9	4,2	78	0,75	53	1,9			

All motors are certified as follows: :

TUV IT 13 ATEX 038X version IIB (T.amb. -40;+60 °C for T4 and T5)

TUV IT 13 ATEX 039X version IIC (T.amb. -20;+60 °C for T4 and -20,+50 for T5)



5.3 Three phase motors 2 speed Quadratic Torque (For centrifugal machines)

- Three phase asynchronous motor, squirrel cage rotor, self ventilated (IC411).
- Duty S1, Insulation class "F", IP55, 400V- 50 Hz.

• Connections	Poles	Connections	High Speed	Low Speed
	2/4 – 4/8	(Dahlander)	YY 400 V	Y 400V
	4/6 – 6/8	(2 Separate windings)	Y 400 V	Y 400V

- For ambient temperature see par 2.1

2 speed 3000/1500 QUADRATIC TORQUE - Rated data at 400V 50Hz															
Code		Type	Poles	P kW	rpm min ⁻¹	In 400 V Amp.	I _a /I _n	η %	Cos φ	M _n Nm	M _g /M _n	m Kg	Class T	Moment of inertia J 10 ⁻³ Kg.m ²	
RL6001	RL 2QT 63 B	2/4	0,25	2780	1,1	3,3	52	0,7	0,9	2	7	T4	0,1		
				1410	0,4	2,5	58	0,68	0,4	1,7					
RL6002	RL 2QT 71 A	2/4	0,37	2790	1,3	3,5	59	0,8	1,3	1,8	7	T4	0,4		
				1410	0,7	2,8	33	0,7	0,6	1,8					
RL6003	RL 2QT 71 B	2/4	0,50	2800	2,1	3,6	60	0,7	1,7	1,8	8	T4	0,4		
				1410	0,65	2,9	65	0,7	1	1,9					
RL6004	RL 2QT 80 A	2/4	0,75	2800	2,46	4	63	0,76	2,6	1,8	11	T4	0,6		
				1415	0,7	3,5	66	0,79	1,2	2,2					
RL6005	RL 2QT 80 B	2/4	1,10	2810	3,2	4,1	66	0,81	3,7	1,8	13	T4	0,8		
				1415	0,84	3,7	70	0,81	1,7	2,2					
RL6006	RL 2QT 90 S	2/4	1,50	2820	4,2	4,5	66	0,82	5,1	2	17,5	T4	1,2		
				1420	1,2	3,9	64	0,81	2,5	2,2					
RL6007	RL 2QT 90 L	2/4	2,20	2860	5,2	4,4	70	0,89	7,5	1,9	19	T4	1,5		
				1400	1,5	4,4	67	0,87	3,7	2,1					
RL6008	RL 2QT 100 LA	2/4	2,60	2820	5,8	5,6	77	0,92	8,8	2,1	25	T4	2,9		
				1420	1,92	5,3	73	0,89	4,2	2					
RL6009	RL 2QT 100 LB	2/4	3,30	2800	7,14	5,6	78	0,92	11,3	2,1	27	T4	2,9		
				1415	2,1	5	73	0,9	5,1	2					
RL6010	RL 2QT 112 M	2/4	4,40	2890	9	5,4	76	0,95	14,6	2	35	T4	7,4		
				1440	2,8	5	76	0,9	7,4	1,9					
RL6035	RL 2QT 132 S	2/4	6,50	2900	13,4	6,1	84	0,92	21,4	2,2	60	T4	15		
				1450	5,7	5,9	75	0,81	13,1	2,1					
RL6036	RL 2QT 132 M	2/4	8,50	2910	16,9	6,7	92	0,83	28,1	2,3	66	T4	17,8		
				1450	5,9	6,4	90	0,80	16,4	2,3					
RL6037	RL 2QT 132 L	2/4	9,20	2900	18,4	6,8	89	0,85	30,5	2,4	71	T4	21,6		
				1450	6,6	6,5	86	0,83	18,5	2,3					
RL6038	RL 2QT 160 M	2/4	12,00	2930	26,9	6,1	76	0,90	39,0	3,5	105	T4	36		
				1450	8,9	4,3	69	0,82	19,6	2,2					
RL6039	RL 2QT 160 L	2/4	16,00	2930	29,4	7,3	86	0,94	52,0	2,1	115	T4	53,4		
				14760	11,40	6,9	79	0,8	28,5	2					

All motors are certified as follows: :

TUV IT 13 ATEX 038X version IIB (T.amb. -40;+60 °C for T4 and T5)

TUV IT 13 ATEX 039X version IIC (T.amb. -20;+60 °C for T4 and -20,+50 for T5)



2 speed 1500/750 QUADRATIC TORQUE - Rated data at 400V 50Hz															
Code	Type	Poles	P kW	rpm min ⁻¹	I _n 400 V Amp.	I _a /I _n	η%	Cos φ	M _n Nm	M _a /M _n	m Kg	Class T	Moment of inertia J 10 ⁻³ Kg.m ²		
RL6011	RL 2QT	71	A	4/8	0,25	1400	0,89	3	70	0,75	1,7	2,2	6.5	T4	0,9
					0,05	700	0,56	2,3	28	0,68	0,7	2,8			
RL6012	RL 2QT	71	B	4/8	0,37	1380	1,3	2,5	59	0,8	2,6	1,2	7.5	T4	0,9
					0,07	680	0,65	1,4	33	0,7	1,1	1,2			
RL6013	RL 2QT	80	A	4/8	0,55	1405	1,63	4,4	75	0,74	3,7	2,2	10	T4	1,3
					0,10	700	0,78	2	38	0,66	1,4	2,3			
RL6014	RL 2QT	80	B	4/8	0,75	1410	2,1	4,1	70	0,76	5,1	1,7	12	T4	1,3
					0,15	690	0,9	2,4	48	0,66	2,1	1,5			
RL6015	RL 2QT	90	S	4/8	0,90	1415	2,95	4	77	0,75	6,1	2,3	16	T4	2
					0,25	710	1,16	2,9	54	0,7	3,4	2,8			
RL6016	RL 2QT	90	L	4/8	1,20	1420	3,6	4,2	80	0,79	8,1	2,3	17.5	T4	2,6
					0,30	710	1,3	1,3	57	0,7	4	3			
RL6017	RL 2QT	100	LA	4/8	1,90	1390	4,6	5	80	0,8	13,1	3	23	T4	5,3
					0,45	710	2,1	3	61	0,68	6,1	2			
RL6018	RL 2QT	100	LB	4/8	2,20	1440	5,4	6	84	0,85	14,6	2,5	25	T4	5,3
					0,55	720	2,2	3	68	0,7	7,3	2,4			
RL6019	RL 2QT	112	M	4/8	3,00	1450	7,1	6	83	0,85	19,8	2,6	35	T4	10,3
					0,75	720	2,77	3	70	0,68	9,9	2,4			
RL6040	RL 2QT	132	S	4/8	4,40	1450	10,2	5,8	85	0,82	29,0	2,2	60	T4	25
					1,10	710	4,1	3,5	72	0,73	15,00	1,9			
RL6041	RL 2QT	132	MB	4/8	5,90	1445	12,9	6,2	87	0,84	39,0	2,1	66	T4	32,4
					1,50	705	5,3	3,9	79	0,64	20,0	1,8			
RL6042	RL 2QT	132	L	4/8	7,50	1450	15,9	6,7	87	0,84	50,0	2,1	71	T4	40,5
					1,85	705	5,9	4,3	80	0,70	25,0	1,9			
RL6043	RL 2QT	160	M	4/8	8,80	1450	19,4	6,8	83	0,84	58,3	2,2	106	T4	62,7
					2,50	710	7,0	3,9	82	0,75	32,8	2,9			
RL6044	RL 2QT	160	L	4/8	12,00	1460	24,3	6,8	88	0,85	78,6	2,2	118	T4	80,1
					3,20	715	8,5	4,0	83,5	0,74	42,2	2,1			

All motors are certified as follows :

TUV IT 13 ATEX 038X version IIB (T.amb. -40;+60 °C for T4 and T5)

TUV IT 13 ATEX 039X version IIC (T.amb. -20;+60 °C for T4 and -20,+50 for T5)



2 speed 1500/1000					QUADRATIC TORQUE - Rated data at 400V 50Hz											
Code		Type	Poles	P kW	rpm min ⁻¹	In 400 V Amp.	I _a /I _n	η%	Cos φ	M _n Nm	M _a /M _n	m Kg	Class T	Moment of inertia J 10 ⁻³ Kg.m ²		
RL6020	RL 2QT	71 B	4/6	0,30	1400	0,95	2,6	71	0,75	2,1	2,0	7,5	T4	0,9		
				0,10	900	0,50	1,4	63	0,72	1,4	1,8					
RL6021	RL 2QT	80 A	4/6	0,44	1405	1,40	3,2	59	0,8	3,0	1,5	10	T4	1,3		
				0,13	900	0,85	1,7	33	0,7	1,4	1,1					
RL6022	RL 2QT	80 B	4/6	0,59	1405	1,80	3,5	76	0,8	3,9	1,7	12	T4	1,3		
				0,18	905	0,85	2,3	72	0,75	1,9	1,2					
RL6023	RL 2QT	90 S	4/6	0,90	1400	2,45	4,1	77	0,75	6,1	2,1	16	T4	2		
				0,30	900	1,03	3,1	68	0,76	3,1	1,6					
RL6024	RL 2QT	90 L	4/6	1,15	1420	2,80	4,1	80	0,79	7,5	1,8	17,5	T4	2,6		
				0,40	910	1,30	2,9	74	0,74	4,2	1,3					
RL6025	RL 2QT	100 LA	4/6	1,80	1410	3,87	5,1	80	0,83	12,1	2,1	23	T4	5,3		
				0,60	930	1,64	3,9	80	0,75	6,1	1,8					
RL6026	RL 2QT	100 LB	4/6	2,20	1440	5,40	3,8	82	0,87	15,2	1,7	25	T4	5,3		
				0,70	940	2,60	3,0	80	0,75	7,5	1,5					
RL6027	RL 2QT	112 M	4/6	3,00	1450	6,80	5,5	84	0,82	19,8	2,0	35	T4	10,3		
				0,90	940	2,50	4,0	81	0,79	9,1	1,9					
RL6045	RL 2QT	132 S	4/6	4,00	1450	9,40	6,3	84	0,82	26,0	2,1	55	T4	25		
				1,20	945	3,90	4,9	80	0,75	11,8	1,7					
RL6046	RL 2QT	132 MA	4/6	4,80	1460	12,30	6,6	75	0,81	31,2	1,9	60	T4	32,4		
				1,40	970	6,00	5,2	69	0,6	14,0	1,9					
RL6047	RL 2QT	132 MB	4/6	5,50	1455	13,80	5,4	77	0,81	36,0	2,1	66	T4	32,4		
				1,70	960	7,40	4,8	64	0,62	17,0	1,9					
RL6048	RL 2QT	132 L	4/6	6,60	1460	16,30	6,7	89	0,72	43,2	1,9	71	T4	40,5		
				2,00	950	8,90	5,2	78	0,55	20,1	1,9					
RL6049	RL 2QT	160 M	4/6	7,50	1470	17,40	7,2	81	0,85	49,0	2,2	106	T4	62,7		
				2,50	985	8,20	5,9	72	0,72	24,2	2,3					
RL6050	RL 2QT	160 L	4/6	11,00	1450	23,80	6,9	84	0,85	72,0	2,2	118	T4	80,1		
				3,30	960	10,30	6,1	73	0,72	32,0	2,3					

All motors are certified as follows: :

TUV IT 13 ATEX 038X version IIB (T.amb. -40;+60 °C for T4 and T5)

TUV IT 13 ATEX 039X version IIC (T.amb. -20;+60 °C for T4 and -20,+50 for T5)



2 speed 1500/750						QUADRATIC TORQUE -Rated data at 400V 50Hz										
Code		Type		Poles	P kW	rpm min ⁻¹	In 400 V Amp.	I _a /I _n	η%	Cosφ	M _n Nm	M _g /M _n	m Kg	T Class	Moment of inertia J 10 ⁻³ Kg.m ²	
RL6028	RL 2QT	80	A	6/8	0,33	920	1,52	3,1	55	0,70	3,4	1,8	10	T4	2,7	
					0,09	680	0,60	1,9	57	0,62	1,3	1,4				
RL6029	RL 2QT	80	B	6/8	0,40	935	1,68	2,9	58	0,70	4,0	1,8	12	T4	2,7	
					0,12	685	0,70	2,1	55	0,63	1,7	1,4				
RL6030	RL 2QT	90	S	6/8	0,48	925	1,98	3,1	61	0,65	4,8	1,9	16	T4	3,4	
					0,19	690	1,05	2,1	55	0,62	2,7	1,5				
RL6031	RL 2QT	90	L	6/8	0,66	900	3,00	3,2	60	0,80	7,1	2,0	17,5	T4	4,9	
					0,25	700	1,40	2,3	52	0,62	3,5	1,7				
RL6032	RL 2QT	100	LA	6/8	0,90	960	3,35	4,1	67	0,68	8,9	1,9	23	T4	8,8	
					0,37	720	2,25	3,5	50	0,65	4,8	1,8				
RL6033	RL 2QT	100	LB	6/8	1,10	950	3,85	3,9	70	0,70	11,2	1,6	25	T4	8,8	
					0,45	720	2,60	3,4	52	0,64	5,9	1,4				
RL6034	RL 2QT	112	M	6/8	1,50	970	4,40	4,4	75	0,74	15,1	2,1	35	T4	17,2	
					0,75	720	3,20	3,5	61	0,68	10,1	1,7				
RL6051	RL 2QT	132	S	6/8	2,20	960	6,60	4,4	75	0,75	22,2	2,2	60	T4	32,3	
					0,90	720	4,20	3,7	62	0,66	11,9	1,8				
RL6052	RL 2QT	132	MA	6/8	3,00	970	7,90	4,8	77	0,82	29,7	2,1	66	T4	39,5	
					1,20	730	5,80	3,8	61	0,63	15,6	1,8				
RL6053	RL 2QT	132	MB	6/8	3,70	970	9,80	5,1	80	0,77	36,5	2,1	71	T4	50,6	
					1,50	720	5,90	3,8	65	0,70	20,1	2,1				
RL6054	RL 2QT	160	M	6/8	5,50	980	13,30	5,5	88	0,75	53,5	2,2	106	T4	91,9	
					2,50	730	7,70	4,2	84	0,65	32,5	2,3				
RL6055	RL 2QT	160	L	6/8	7,50	970	15,30	5,7	84	0,85	73,5	2,1	118	T4	12,18	
					4,00	720	10,10	3,9	81	0,80	53,2	2,1				

All motors are certified as follows :

TUV IT 13 ATEX 038X version IIB (T.amb. -40;+60 °C for T4 and T5)

TUV IT 13 ATEX 039X version IIC (T.amb. -20;+60 °C for T4 and -20,+50 for T5)



5.4 Single-phase motors

- Single-phase asynchronous motor, squirrel cage rotor, self-ventilated (IC411).
- Duty S1, Insulation class "F", IP55, 230V - 50 Hz.
- For ambient temperature see par 2.1
- The motors considered in the rating table are single-phase motors with 1 capacitor. In case of single-phase motors with high starting torque it is possible to have a start capacitor complete with electronic switch (on request mechanical).

Rated data at 230V/50Hz																	
Code	Type			Poles	P Kw Hp		rpm min ⁻¹	In Amp	Ia/In	η%	cos φ	Mn Nm	Ma/Mn	Cap. μF	m Kg	Classe T	Certificate
RL8001	RL	56	A	2	0,06	0,08	2710	0,8	2,8	42	0,88	0,15	0,6	5	4	T4	1or2 3
RL8002	RL	56	B	2	0,09	0,12	2709	0,93	3	43	0,9	0,2	0,6	3	4,5	T4	1or2 3
RL8003	RL	63	A	2	0,12	0,16	2770	1,43	3,2	50	0,9	0,3	0,7	6,3	6,5	T4	1or2 3
RL8004	RL	63	B	2	0,18	0,25	2780	1,96	3,7	51	0,86	0,55	0,7	6,3	7	T4	1or2 3
RL8005	RL	71	A	2	0,25	0,34	2785	2,28	3,6	60	0,93	0,75	0,8	8	7	T4	1or2 3
RL8006	RL	71	B	2	0,37	0,50	2800	3,30	2,6	62	0,97	1,5	0,8	10	8	T4	1or2 3
RL8007	RL	80	A	2	0,55	0,75	2810	3,79	2,4	61	0,97	1,95	0,7	16	10,5	T4	3
RL8008	RL	80	B	2	0,75	1,00	2840	4,82	4,4	62	0,94	2,7	0,9	20	11,5	T4	3
RL8009	RL	90	S	2	1,1	1,50	2850	7,60	4,3	67	0,89	3,9	0,8	25	16,5	T4	3
RL8010	RL	90	L	2	1,5	2,00	2850	12,30	4,8	67	0,94	5,0	0,8	30	18	T4	3
RL8011	RL	100	LA	2	2,2	3,00	2700	14,30	4,9	69	0,93	7,4	0,7	35	25	T4	3
RL8012	RL	100	LB	2	3	4,00	2810	18,00	4,9	72	0,95	10,1	0,7	50	27	T4	3
RL8013	RL	56	B	4	0,06	0,08	1285	0,88	2,7	49	0,9	0,4	0,6	3,75	4,5	T4	1or2 3
RL8014	RL	63	A	4	0,09	0,12	1390	0,98	3,1	51	0,876	0,6	0,7	5	6	T4	1or2 3
RL8015	RL	63	B	4	0,12	0,16	1385	1,2	2,9	53	0,86	1,1	0,7	6,3	6,5	T4	1or2 3
RL8016	RL	71	A	4	0,18	0,25	1390	1,75	3,1	61	0,83	1,8	0,8	8	7,5	T4	1or2 3
RL8017	RL	71	B	4	0,25	0,34	1385	2,1	3,2	63	0,85	2,3	0,8	8	7,5	T4	1or2 3
RL8018	RL	80	A	4	0,37	0,50	1395	2,88	2,7	63	0,94	2,9	0,8	12,5	10,5	T4	3
RL8019	RL	80	B	4	0,55	0,75	1380	4,07	3,7	64	0,96	3,8	0,8	16	11,5	T4	3
RL8020	RL	90	S	4	0,75	1,00	1380	5,5	3,1	69	0,9	5,1	0,95	20	16,5	T4	3
RL8021	RL	90	L	4	1,1	1,50	1380	7,9	3,9	69	0,9	7,2	0,7	25	18	T4	3
RL8022	RL	100	LA	4	1,3	1,75	1385	8,80	3,2	71	0,96	9,0	0,55	32	25	T4	3
RL8023	RL	100	LB	4	1,6	2,20	1440	10,95	2,6	75	0,9	11,1	0,55	45	27	T4	3
RL8024	RL	63	A	6	0,06	0,08	890	0,80	2,4	50	0,85	0,6	0,5	6,3	6	T4	1or2 3
RL8025	RL	63	B	6	0,09	0,12	902	1,52	2,3	60	0,82	0,8	0,5	8	6,5	T4	1or2 3
RL8026	RL	71	A	6	0,12	0,16	910	1,40	2,5	61	0,83	1,2	0,6	8	6,5	T4	1or2 3
RL8027	RL	71	B	6	0,18	0,25	840	3,10	2,7	61	0,91	1,8	0,6	12,5	7,5	T4	1or2 3
RL8028	RL	80	A	6	0,25	0,34	920	3,00	2,8	62	0,92	2,2	0,6	16	10	T4	3
RL8029	RL	80	B	6	0,37	0,50	900	2,84	2,9	65	0,85	3,2	0,7	20	12	T4	3
RL8030	RL	90	S	6	0,55	0,75	910	4,20	2,9	65	0,85	5,9	0,7	25	16	T4	3
RL8031	RL	90	L	6	0,75	1,00	900	5,90	3,1	68	0,90	8,1	0,7	32	17,5	T4	3
RL8032	RL	100	LA	6	1,10	1,50	920	8,76	3,1	69	0,90	11,5	0,7	45	23	T4	3

1--> II 2 G Ex d IIC or II 2 D Ex tb IIIC terminal box for 3 phase motor (type a) TUV IT 13 ATEX 039X (T. amb. -20;+60°C)
 2--> II 2 G Ex d IIB or II 2 D Ex tb IIIC terminal box for 3 phase motor (type a) TUV IT 13 ATEX 038X (T.amb. -40 ;+60°C)
 3--> II 2 G Ex d IIB or II 2 D Ex tb IIIC terminal box for 1 phase motor (type c-d-e) TUV IT 14 ATEX 029X (T. amb. -20 ;+60°C)
 TUV IT 12 ATEX 070X version IIC (T.amb. -40;+60 °C for T4 -T5-T6) valid for TUBE MOTORS
 Frames 71 and 63 are interchangeable.



6. OVERALL DIMENSIONS

6.1 Three-phase motors

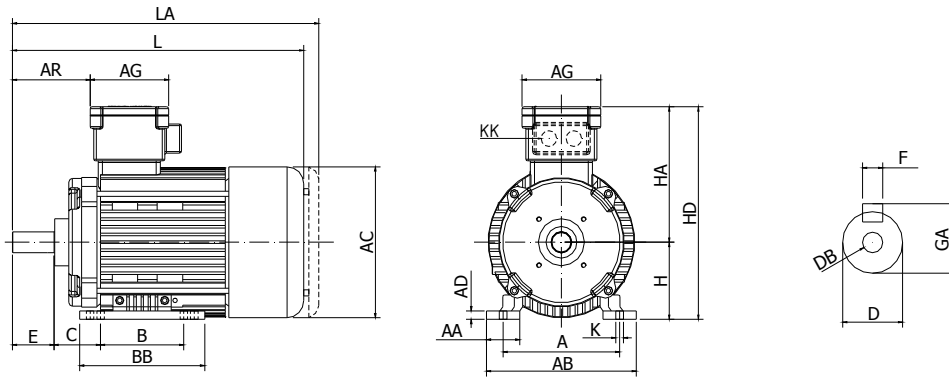

Mounting B3

Shaft

Type	A	AA	AB	AC	AD	AG	AR	B	BB	C	K	KK	H	HA	HD	L	LA	D	DB	E	F	GA
56	90	24	108	110	9	94,2	46,9	71	84	36	6,2	M20x1,5	56	125	181	211,5	223	9j6	M3	20	3	10,2
63	100	25	125	131	6	94,2	63,4	80	108	40	7,0	M20x1,5	63	142	205	270,8	283	11j6	M4	23	4	12,5
71	112	30	142	138	8	94,2	64,4	90	120	45	7,0	M20x1,5	71	142	213	271,8	284	14j6	M5	30	5	16
80	125	30	155	156	8	4,2	80,4	100	125	50	9,0	M20x1,5	80	151	231	299	314	19j6	M6	40	6	21,5
90S	140	40	180	176	10	94,2	93,4	100	150	56	9,0	M20x1,5	90	158	248	350	368	24j6	M8	50	8	27
90L	140	40	180	176	10	94,2	93,4	125	150	56	9,0	M20x1,5	90	158	248	350	368	24j6	M8	50	8	27
100	160	40	200	197	12	123,5	107	140	180	63	12,0	M25x1,5	100	188	288	404	416	28j6	M10	60	8	31
112	190	40	230	218	12	123,5	112,3	140	180	70	12,0	M25x1,5	112	198	310	418	442	28j6	M10	60	8	31
132S	216	63	248	257	16	168	177	140	175	89	12	M32X1,5	132	247	379	553	566	38k6	M12	80	10	41
132M	216	63	248	257	16	168	177	178	213	89	12	M32X1,5	132	247	379	553	566	38k6	M12	80	10	41
160M	254	70	310	310	20	168	215	210	255	108	14	M32X1,5	160	285	445	670	688	42k6	M16	110	12	45
160L	254	70	310	310	20	168	215	254	300	108	14	M32X1,5	160	285	445	670	688	42k6	M16	110	12	45

For code RL 0071/0072/0073 L/LA= +80mm B=254/BB=300

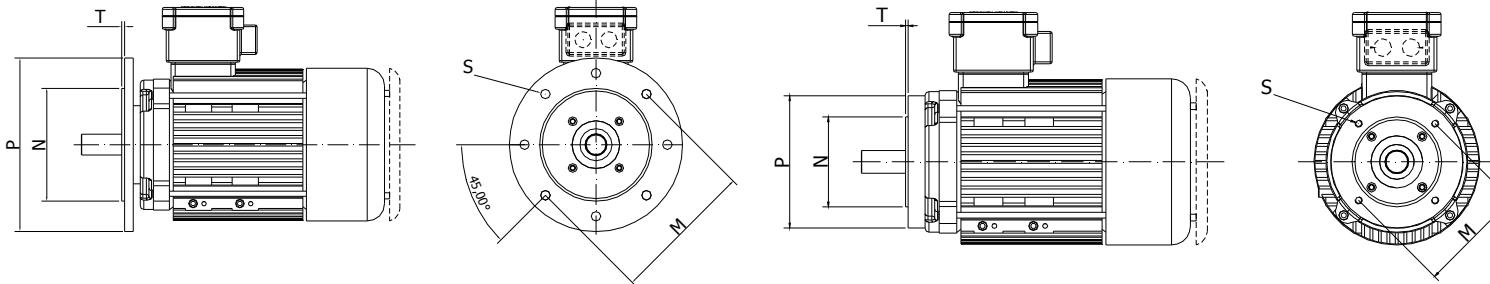

Mounting B5

4 (8) holes - 45°

Type	P	N	M	S	T
56	120	80j6	100	7	3
63	140	95j6	115	9	3
71	160	110j6	130	10	3,5
80	200	130j6	165	12	3,5
90S	200	130j6	165	12	3,5
90L	200	130j6	165	12	3,5
100	250	180j6	215	15	4
112	250	180j6	215	15	4
132S	300	230j6	265	15	4
132M	300	230j6	265	15	4
160M	350	250h6	300	18	5
160L	350	250h6	300	18	5

Mounting B14

4 holes - 45°

Type	P	N	M	S	T
56	76	50j6	65	M5	2,5
63	90	60j6	75	M5	2,5
71	105	70j6	85	M6	2,5
80	120	80j6	100	M6	3
90S	140	95j6	115	M8	3
90L	140	95j6	115	M8	3
100	160	110j6	130	M8	3,5
112	160	110j6	130	M8	3,5
132S	200	130j6	165	M10	3,5
132M	200	130j6	165	M10	3,5
160M	250	180h6	215	M12	4
160L	250	180h6	215	M12	4



6.2 Forced Ventilation Motors

Length of motors complete with forced ventilation (auxiliary motor frame 56)

Frame	63	71	80	90S	90L	100	112	132S	132M	160M	160L
L	519,5	520,5	574	624	624	678	698	865	945	994	1074

6.3 Single-phase motors

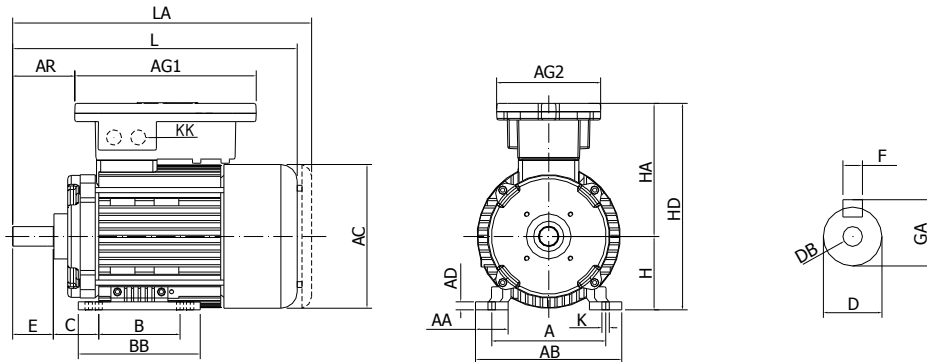

Type	Mounting B3														Shaft							
	A	AA	AB	AC	AD	AG1 AG2	AR	B	BB	C	K	KK	H	HA	HD	L	LA	D	DB	E	F	GA
56 (IIB)	90	24	108	110	9	223 128	46,9	71	84	36	6,2	M20x1,5	56	125	181	211,5	220	9j6	M3	20	3	10,2
56 (IIC)	90	24	108	110	9	94,2	46,9	71	84	36	6,2	M20x1,5	56	125	181	211,5	223	9j6	M3	20	3	10,2
63 (IIB)	100	25	125	131	6	223 128	46,5	80	108	40	7,0	M20x1,5	63	146,5	209,5	270,8	283	11j6	M4	23	4	12,5
63 (IIC)	100	25	125	131	6	94,2	63,4	80	108	40	7,0	M20x1,5	63	142	205	270,8	283	11j6	M4	23	4	12,5
71 (IIB)	112	30	142	138	8	223 128	47,5	90	120	45	7,0	M20x1,5	71	146,5	217,5	271,8	284	14j6	M5	30	5	16
71 (IIC)	112	30	142	138	8	94,2	64,4	90	120	45	7,0	M20x1,5	71	142	213	271,8	284	14j6	M5	30	5	16
80	125	30	155	156	8	223 128	63,5	100	125	50	9,0	M20x1,5	80	155,5	235,5	299	314	19j6	M6	40	6	21,5
90S	140	40	180	176	10	223 128	76,5	100	150	56	9,0	M20x1,5	90	162,5	252,5	350	368	24j6	M8	50	8	27
90L	140	40	180	176	10	223 128	76,5	125	150	56	9,0	M20x1,5	90	162,5	252,5	350	368	24j6	M8	50	8	27
100	160	40	200	197	12	206 190	96,0	140	180	63	12,0	M20x1,5	100	208	308	404	416	28j6	M10	60	8	31

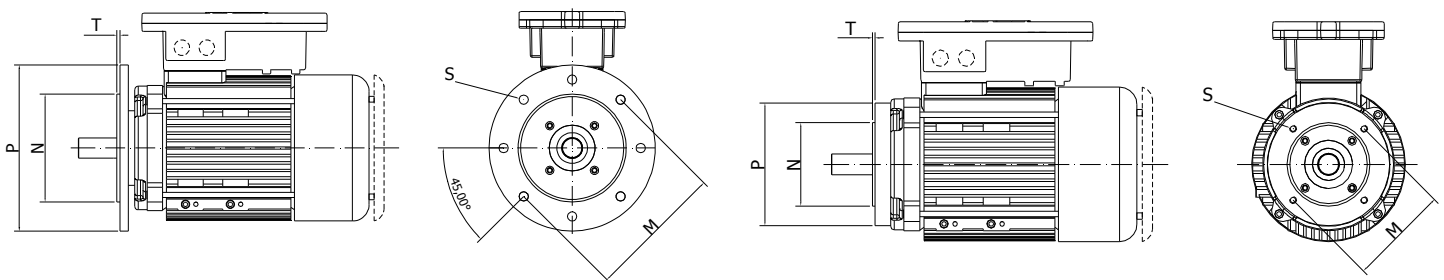

Mounting B5					
4 (8) holes - 45°					
Type	P	N	M	S	T
56	120	80j6	100	7	3
63	140	95j6	115	9	3
71	160	110j6	130	10	3,5
80	200	130j6	165	12	3,5
90S	200	130j6	165	12	3,5
90L	200	130j6	165	12	3,5
100	250	180j6	215	15	4

Mounting B14					
4 holes - 45°					
Type	P	N	M	S	T
56	76	50j6	65	M5	2,5
63	90	60j6	75	M5	2,5
71	105	70j6	85	M6	2,5
80	120	80j6	100	M6	3
90S	140	95j6	115	M8	3
90L	140	95j6	115	M8	3
100	160	110j6	130	M8	3,5

6.4 Tube Series

B3 Mounting

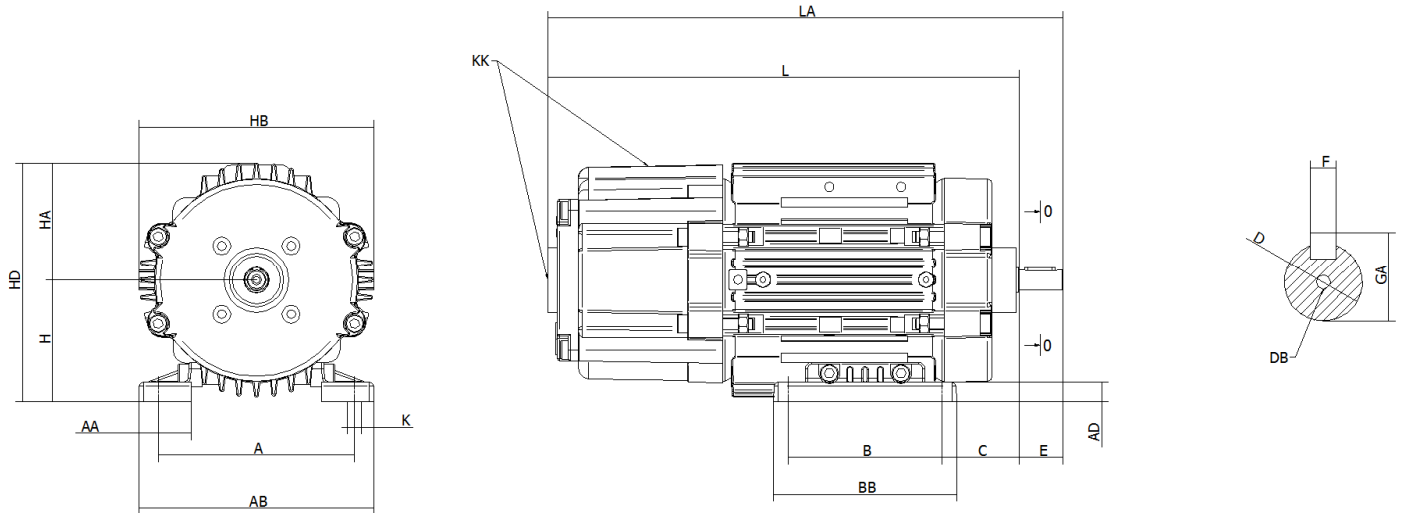

Mounting B3																Shaft				
Type	A	AA	AB	B	BB	AD	C	H	HA	HD	L	LA	HB	KK	K	D	DB	E	F	GA
56	90	24	108	71	84	9	36	56	56	112	217	237	108	M20x1.5	6.2	9 j6	M3	20	3	10.2
63	100	25	125	80	108	6	40	63	65	128	252	275	124	M20x1.5	7	11 j6	M4	23	4	12.5
71	112	30	142	90	120	8	45	71	65	136	245	275	124	M20x1.5	7	14 j6	M5	30	5	16

B5/B14 Mounting

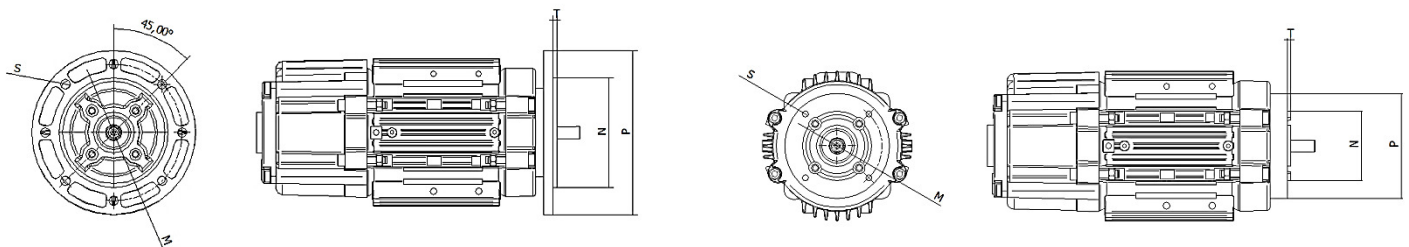

Mounting B5 4 (8) holes - 45°					
Type	P	N	M	S	T
56	120	80 j6	100	7	3
63	140	95 j6	115	9	3
71	160	110 j6	130	10	3.5

Mounting B14 4 holes - 45°					
Type	P	N	M	S	T
56	76	50 j6	65	M5	2.5
63	90	60 j6	75	M5	2.5
71	105	70 j6	85	M6	2.5

6.5 Terminal box

D-Three-phase 56 - 63 - 71 - 80 - 90 / Single-phase 56 - 63 - 71 (IIC)

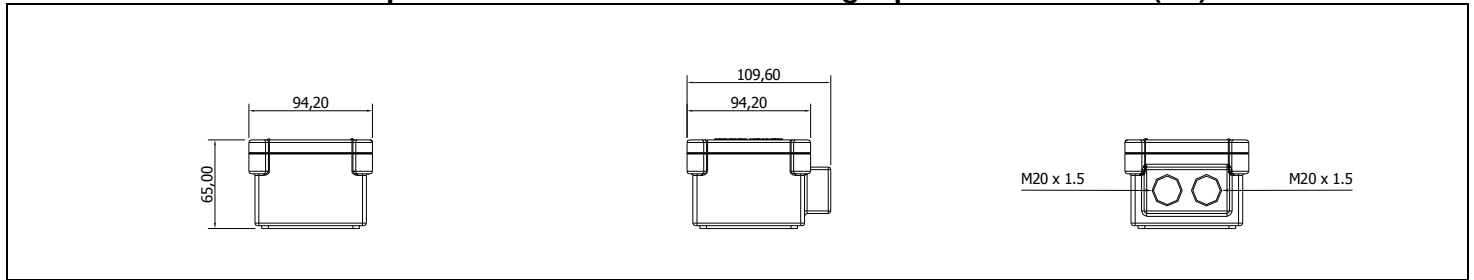

Three-phase 100 - 112 (IIC)

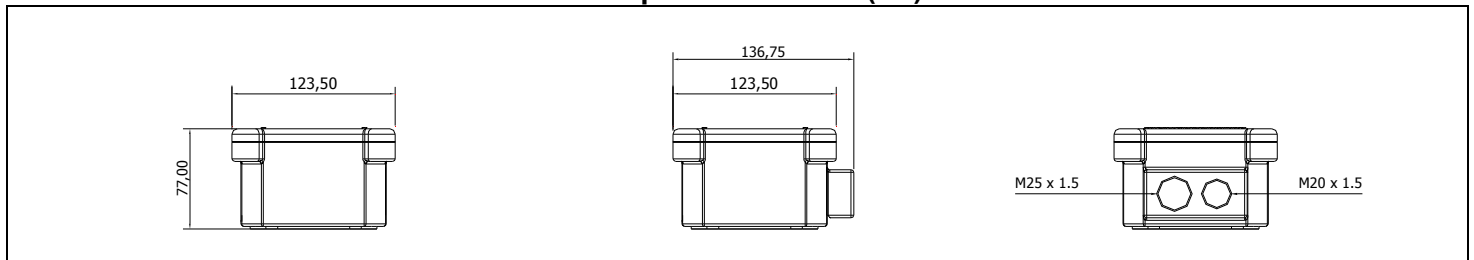

Three-phase 132 - 160 (IIC)

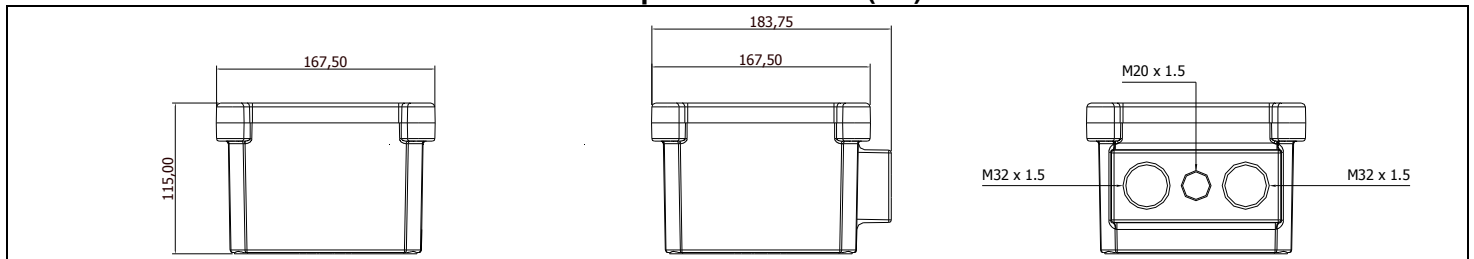

Single-phase 56 - 63 - 71 - 80 - 90 (IIB)

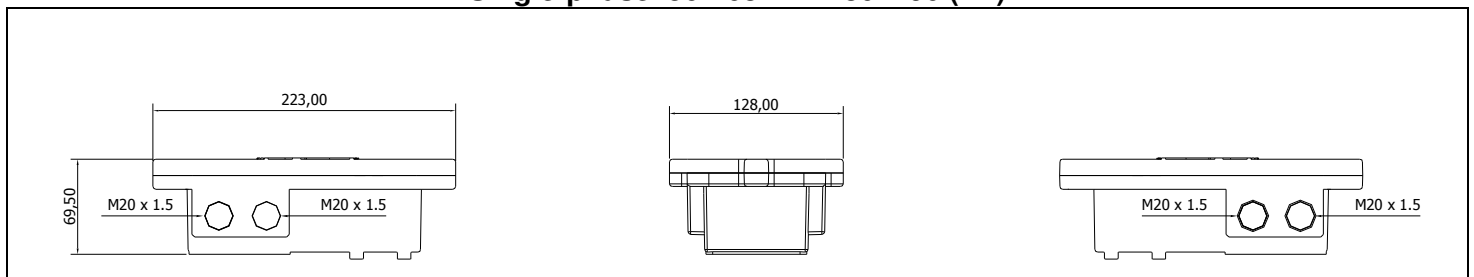

Single-phase 2 Capacitors - High starting torque 63 - 71 - 80 - 90 - 100 (IIB)

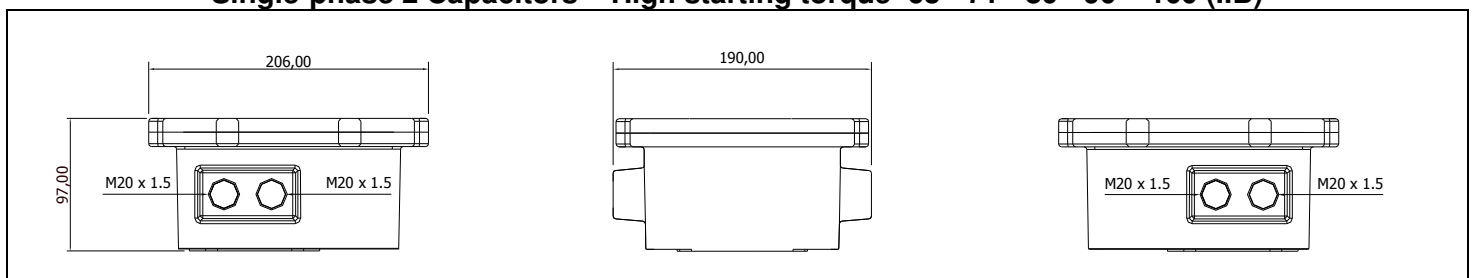

Special 56 - 63 - 71 - 80 - 90 - 100 - 112 (IIB)

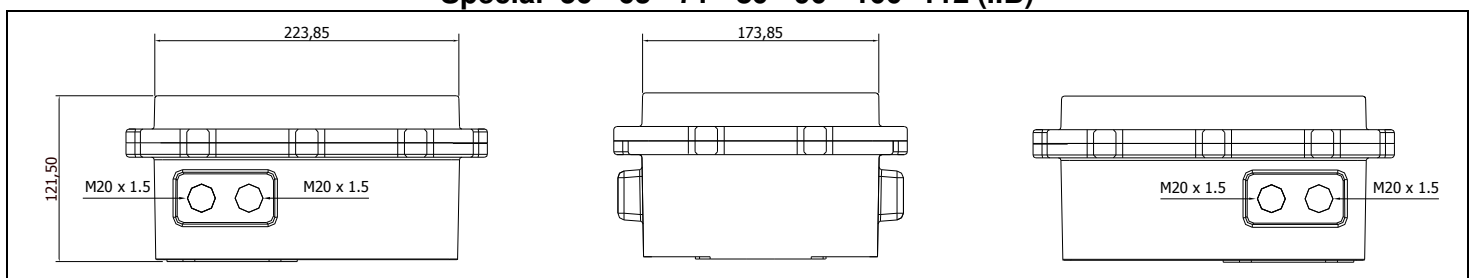



7. SPARE PARTS

7.1 Personnel qualification

Overhauls and repairs must be only realised by qualified people in accordance with the standards EN 60079-17 or national standards (last edition). Qualified people must have knowledge about explosion protection.

Repairs must be made regarding the rules as define in EN 60079-19 standards.

These repairs can only be done under the control or agreement with Motori Elettrici by a repair shop designed by RAEL or a recognized laboratory.

In case these rules are not respected, liability is released.

7.2 List of spare parts

All motors components must be replaced by original spare parts. In these cases please contact RAEL directly and give the serial number of the motor so to ask the authorization to repair the motor too.

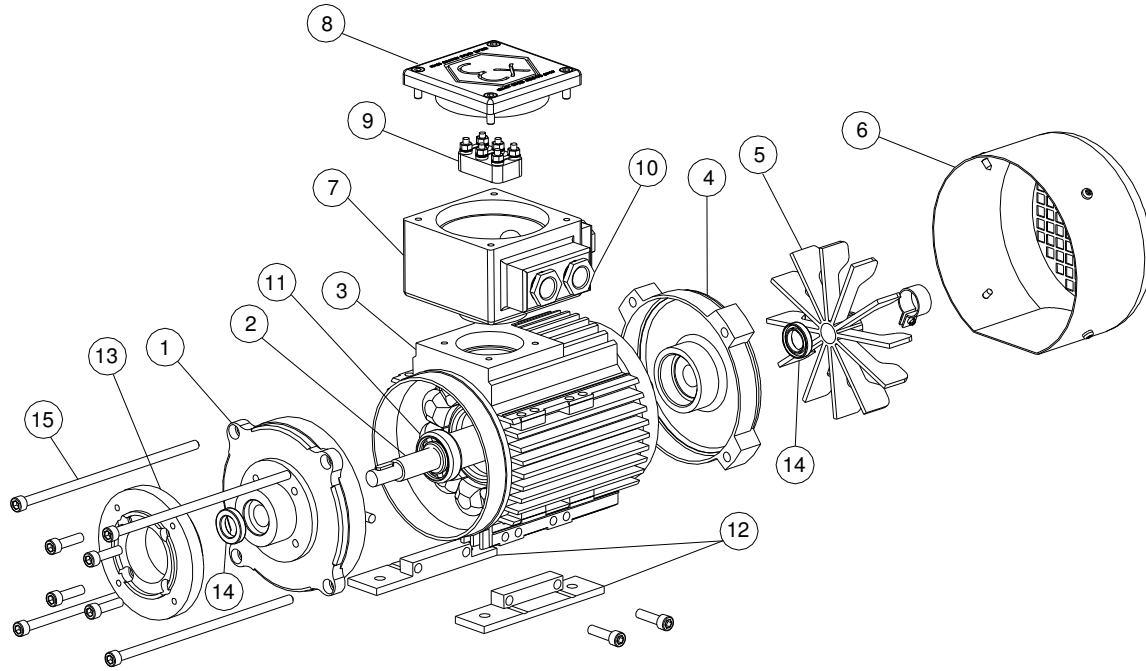

1	DRIVE END SHIELD	6	FAN COVER	11	BALL BEARINGS
2	SHAFT WITH ROTOR	7	TERMINAL BOX	12	MOTOR FEET
3	FRAME	8	TERMINAL BOX COVER	13	FLANGE B14 (or B5)
4	NO-DRIVE END SHIELD	9	TERMINAL BLOCK	14	ABY ANGULAR BEARING
5	COOLING FAN	10	CABLE GLAND	15	TIE RODS (quality 4.8)

SCREWS

Screws quality 8.8

	56	63	71	80	90	100	112	132	160
FLANGE B14 (o B5)	M5x14	M6x20	M6x16	M6x16	M6x20	M6x20	M6x20	M8x25	M8x25
MOTOR FEET	M5x10	M6x12	M6x14	M6x16	M6x16	M8x20	M8x25	M8x20	M8x25
TERMINAL BOX COVER	M5x14	M5x14	M5x14	M5x14	M5x14	M5x20	M5x20	M8x20	M8x20

	M4	M5	M6	M8	M10
TIGHTENING TORQUE (Nm)	2	3.2	5	12	18



RL

series



RL 90 B3 3PH



RL 71 B35



RL 132 B3



RL 71 B14 No Tbox



RL 56 B5

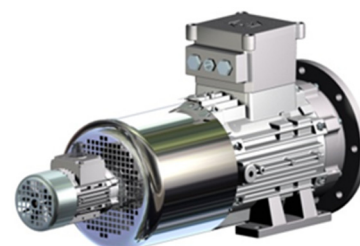

RL 132C B35 Forced ventilation +
Encoder



RL 90 B35 Box A



RL 90 B14 Box B



RL 80 B5 Encoder



RL 160 B3 Pos B





TUBE

series

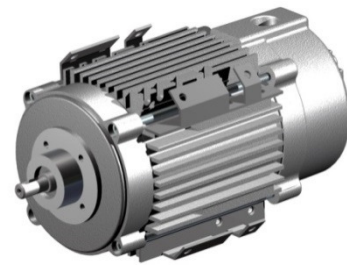

RL 63 B30



RL 56 B5

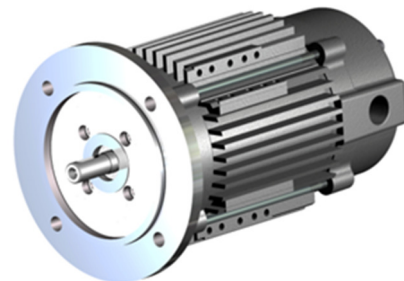

RL 71 B5



RL 63 B30



**Our Company is certified ISO 9001:2015.
Rael produces motors in compliance to directive
2014/34 EU.**

**Our Motors have been tested in accredited
laboratories, and they have EU certificate**

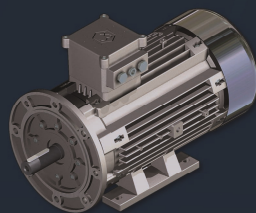

 **RAEL** MOTORI
ELETTRICI

Rael Motori Elettrici s.r.l.

Via per Retorto 7/1
15077 Predosa
ITALY

tel + 39 0131 71563

fax + 39 0131 71503

info@raelsrl.com

www.raelsrl.com