

**Witra**<sup>®</sup>  
Proof of Quality



# MAIN CATALOGUE

---

Industrial Chains, Sprockets  
and Accessories

**Witra**

- 4 Unternehmensprofil  
Company profile

**Rollenketten / Roller chains**

- 14 Einfach-Rollenketten nach ISO 606 (Europäische Bauart)  
Simplex roller chains ISO 606 (European type)
- 15 Zweifach-Rollenketten nach ISO 606 (Europäische Bauart)  
Duplex roller chains ISO 606 (European type)
- 16 Dreifach-Rollenketten nach ISO 606 (Europäische Bauart)  
Triplex roller chains ISO 606 (European type)
- 17 Einfach-Rollenketten Reihe C (gerade Laschen)  
Simplex roller chains series C (straight side plates)
- 18 Zweifach-Rollenketten Reihe C (gerade Laschen)  
Duplex roller chains series C (straight side plates)
- 19 Einfach-Rollenketten nach ISO 606 (Amerikanische Bauart)  
Simplex roller chains according to ISO 606 (American type)
- 20 Zweifach-Rollenketten nach ISO 606 (Amerikanische Bauart)  
Duplex roller chains according to ISO 606 (American type)
- 21 Einfach-Rollenketten nach ISO 606 (schwere Ausführung)  
Simplex roller chains according to ISO 606 (heavy series)
- 22 Zweifach-Rollenketten nach ISO 606 (schwere Ausführung)  
Duplex roller chains according to ISO 606 (heavy series)
- 23 Rollenketten „rostfrei“ - Rollenketten Reihe C „rostfrei“  
Roller chains „stainless steel“ - Roller chains with straight side plates „stainless steel“
- 24 Einfach / Zweifach Rollenketten - vernickelt  
Simplex / Duplex roller chains - nickel plated
- 25 Langgliedrige Rollenketten nach ISO 1275  
Double pitch chains ISO 1275
- 26 Langgliedrige Rollenketten nach ISO 1275 (gerade Laschen)  
Double pitch chains ISO 1275 (straight side plates)

**Hohlbolzenketten / Hollow pin chains**

- 27 Hohlbolzenketten  
Hollow pin chains

**Stauförderketten / Accumulator chains**

- 28 Stauförderketten  
Accumulator chains

**Flyerketten / Leaf chains**

- 29 Flyerketten Reihe LL nach ISO 4347  
Leaf chains LL series according to ISO 4347
- 30 Flyerketten Reihe BL entsprechend LH nach ISO 4347  
Leaf chains BL series according to LH / ISO 4347
- 31 Flyerketten Reihe BL entsprechend LH nach ISO 4347  
Leaf chains BL series according to LH / ISO 4347

**Rollenketten mit U-Bügeln / Roller chains with U-type attachments**

- 32 Rollenketten mit U-Bügeln  
Roller chains with U-type attachments

**Rollenketten mit Elastomer-Profilen / Roller chains with elastomer-profiles**

- 33 Rollenketten mit Elastomer-Profilen  
Roller chains with elastomer-profiles

**Rollenketten „rostfrei“ als Mitnehmerketten / Roller chains „stainless steel“ with one hole attachments**

- 35 Rollenketten „rostfrei“ als Mitnehmerketten  
Roller chains „stainless steel“ with one hole attachments

**Rollenketten mit Winkellaschen / Roller chains with single hole bent attachments**

- 36 Rollenketten mit Winkellaschen  
Roller chains with single hole bent attachments
- 37 Rollenketten mit Flachlaschen und Mitnehmerbolzen  
Roller chains with single hole straight attachments and extended pins
- 38 Rollenketten mit breiten Winkel- und Flachlaschen  
Roller chains with two hole bent and straight attachments
- 39 Rollenketten „rostfrei“ mit breiten Winkel- und Flachlaschen  
Roller chains „stainless steel“ with two hole bent and straight attachments

**Förderketten für die Holzindustrie & Anbauteile / Lumber conveyor chains & attachments**

- 40 Förderketten für die Holzindustrie & Anbauteile  
Lumber conveyor chains & attachments

**Kettenräder / Sprockets**

- 42 Kettenräder nach ISO 606  
Sprockets according to ISO 606

**Kettenradscheiben / Sprocket discs**

- 46 Kettenradscheiben nach ISO 606  
Sprocket discs according to ISO 606

**Pflege und Wartung von Kettentrieben / Maintenance of chain devices**

- 48 Allgemeine Informationen  
Kürzen und Verlängern von Rollenketten
- 50 General information  
Shortening and extending of roller chains



Wippermann Trading Firmensitz in Kirchlengern, Deutschland / Wippermann Trading Headquarter Kirchlengern, Germany

#### **Ihre Vorteile auf einen Blick**

- Optimale Verfügbarkeit unseres gesamten Produktspektrums
- Maßgeschneiderte Individualisierung von Ketten und Kettenrädern
- Schnelle Lieferung innerhalb von 24 Stunden

#### **Your benefits at a glance**

- Optimum availability of the entire product range
- Customization of chains and sprockets
- Fast delivery within 24 hours

# WIPPERMANN TRADING

---

Wir kombinieren kompromisslose Qualität mit Service – seit 1998

Wippermann-Trading, kurz Witra, ist seit 1998 innerhalb der Wippermann-Gruppe unsere Marke für wirtschaftlich besonders attraktive Standard-Ketten und -Kettenräder. Hohe Verfügbarkeit, schnelle Bearbeitung, kombiniert mit einer hervorragenden Qualität, runden unseren Service ab.

Wir bieten ein umfangreiches Sortiment bewährter Rollenketten, Flyerketten, Hohlbolzenketten, Förderketten für die Holzindustrie sowie Kettenräder und Kettenradscheiben. Eine strikte Qualitätsvereinbarung mit unseren Lieferanten, kombiniert mit umfassenden Qualitätskontrollen, sichert ein hohes Maß an technischer und funktionaler Verlässlichkeit der verschiedenen Antriebskomponenten.

Unseren modernen Standort in Kirchlengern haben wir konsequent auf die Anforderungen unserer Kunden ausgerichtet. So bieten wir dank modernster Bearbeitungstechnik kundenspezifische Individualisierungsmöglichkeiten für Kettenräder. Kürzeste Reaktionszeiten werden durch die effiziente Verknüpfung von Verwaltung, Kommissionierung und Versand im Rahmen von optimierten Logistikprozessen ermöglicht.

# WIPPERMANN TRADING

---

Combining uncompromising quality and service – since 1998

Wippermann-Trading, or Witra for short, has been our brand for particularly economical standard chains and sprockets within the Wippermann Group since 1998. High availability and fast processing combined with highest quality complete our service.

We offer an extensive range of proven roller chains, leaf chains, hollow pin chains, lumber conveyor chains as well as sprockets and plate sprockets. A strict quality agreement with our suppliers in combination with comprehensive quality controls ensures a high degree of technical and functional reliability of the various drive components.

Our modern facility in Kirchlengern has been systematically designed to meet the requirements of our customers. Thanks to state-of-the-art machining technology, we can offer individual customization options for sprockets. Shortest response times are made possible by our optimized logistics processes through the efficient integration of administration, picking and dispatch.



Sie benötigen ein von der marktüblichen Länge von fünf Metern abweichendes Maß? Dank unseres modernen Maschinenparks konfektionieren und liefern wir auch kurzfristig Sonderlängen: Unsere automatische Ablängmaschine trennt schnell und passgenau Ketten von einer 100-Meter-Haspel auf Ihre Wunschlänge. Darüber hinaus bieten wir auch eine Individualisierung der Ketten mit verschiedensten Anbauteilen.

Kette ist nicht gleich Kette: Normbedingte Fertigungs- und Bauteiltoleranzen können bei identischen Modellen zu Längendifferenzen führen. Für bestimmte Anwendungen, wie beispielsweise mit paarweisem Lauf, müssen die Ketten über ein exakt identisches Längenmaß verfügen. Dies stellen wir durch den Einsatz unserer hauseigenen Mess- und Streckbank sicher, die das präzise Einstellen der Länge unserer Ketten ermöglicht.

## INDUSTRIEKETTEN

---

Genau abgestimmt auf Ihren Bedarf

### Unsere Services

- Ablängen
- Nieten
- Verlängern
- Ketten mit Anbauteilen konfektionieren
- Paarweises Vorstrecken





# INDUSTRIAL CHAINS

Perfectly tuned to your needs

## Our services

- Cutting to length
- Riveting
- Shortening
- Assembling chains with attachments
- Pre-stretched chains in matched-length



Do you need a chain length different from the usual market length of five metres? Thanks to our modern machinery, we can also assemble and deliver special lengths at short notice: Our automatic cutting machine separates chains quickly and accurately from a 100-metre reel to your required length. In addition, we also offer customized chains with various attachments.

Not all chains are the same: Manufacturing and component tolerances permissible under standards can lead to differences in length for identical models. For certain applications, such as paired running, the chains must have exactly the same length. This is ensured by the use of our in-house measuring and stretching bench, which enables the precise adjustment of the length of our chains.



# LIEFERPROGRAMM INDUSTRIEKETTEN

---

## Schnelligkeit durch Verfügbarkeit

Eine Lieferung innerhalb von 24 Stunden gewährleisten wir durch die Verfügbarkeit unserer Produkte: Auf gut 3.000 qm halten wir in unserem hochmodernen Lagersystem Ketten in den Größen 04-1 bis 56B-3 vor. So können wir nahezu jeden Bedarf unserer Kunden innerhalb kürzester Zeit bedienen. Eine Erweiterungsoption um zusätzliche 50 % der Logistikkapazität sichert die Zukunftsfähigkeit unseres Standortes.

Zu unserem umfassenden Lagersortiment zählen auch Sonderausführungen wie Witra-Rollenketten mit U-Bügeln von 1/2" bis 1" in Simplex- und Duplex-Ausführung. Diese sind insbesondere für Transportgüter in der Baustoffindustrie geeignet.

Für einen schonenden Transport von Gütern mit empfindlichen Oberflächen wie in der Möbelindustrie bevorraten wir Rollenketten mit Elastomer-Profilen von 1/2" bis 3/4" in Simplex- und Duplex-Ausführung und 1" in Simplex-Ausführung. Erweitert wurde das Kettenprogramm zudem um Förderketten von 1" bis 2" in Simplex-Ausführung für die Holz verarbeitende Industrie.

# DELIVERY PROGRAM INDUSTRIAL CHAINS

---

## Speed through availability

The delivery within 24 hours is guaranteed by the availability of our products: On an area of 3.000 sqm we stock chains in sizes 04-1 to 56B-3 in our large storage system. This enables us to meet almost all requirements of our customers within the shortest possible time. There is an option to extend the logistics capacity by another 50 %, making our site viable for the future.

Our comprehensive stock range also includes special designs such as Witra roller chains with U-type attachments from 1/2" to 1" in simplex and duplex.

These are particularly suitable for transport goods in the building materials industry. We stock roller chains with elastomer profiles from 1/2" to 3/4"

in simplex and duplex and 1" in simplex for the gentle transport of goods with sensitive surfaces like those in the furniture industry. The product range has also been extended to lumber conveyor chains from 1" to 2" in simplex design.



**Folgende Kettentypen sind ab Lager lieferbar**

- Rollenketten nach ISO 606 (europäische Bauart)
- Langgliedrige Rollenketten nach ISO 1275 (europäische Bauart)
- Rollenketten nach ISO 606 (amerikanische Bauart)
- Langgliedrige Rollenketten nach ISO 1275 (amerikanische Bauart, mit geraden Laschen)
- Rollenketten nach ISO 606 (amerikanische Bauart, verstärkt)
- Rollenketten mit geraden Laschen
- Rollenketten aus rostfreiem Stahl
- Rollenketten in vernickelter Ausführung
- Flyerketten LL-Serie nach ISO 4347
- Flyerketten BL-Serie nach ISO 4347
- Rollenketten mit Mitnehmerlaschen
- Stauförderketten
- Hohlbolzenketten
- Rollenketten mit U-Bügeln
- Rollenketten mit Elastomer-Profilen
- Förderketten für die Holzindustrie

**The following chain types are available in stock**

- Roller chains according to ISO 606 (european type)
- Double pitch chains according to ISO 1275 (european type)
- Roller chains according to ISO 606 (american type)
- Double pitch chains according to ISO 1275 (american type, straight plates)
- Roller chains according to ISO 606 (american type, heavy series)
- Roller chains with straight side plates
- Roller chains made of stainless steel
- Nickel-plated roller chains
- Leaf chains type series LL according to ISO 4347
- Leaf chains type series BL according to ISO 4347
- Roller chains with attachment side plates
- Accumulator chains
- Hollow pin chains
- Roller chains with U-type attachments
- Roller chains with elastomer-profiles
- Lumber conveyor chains

## Bearbeitungsspektrum

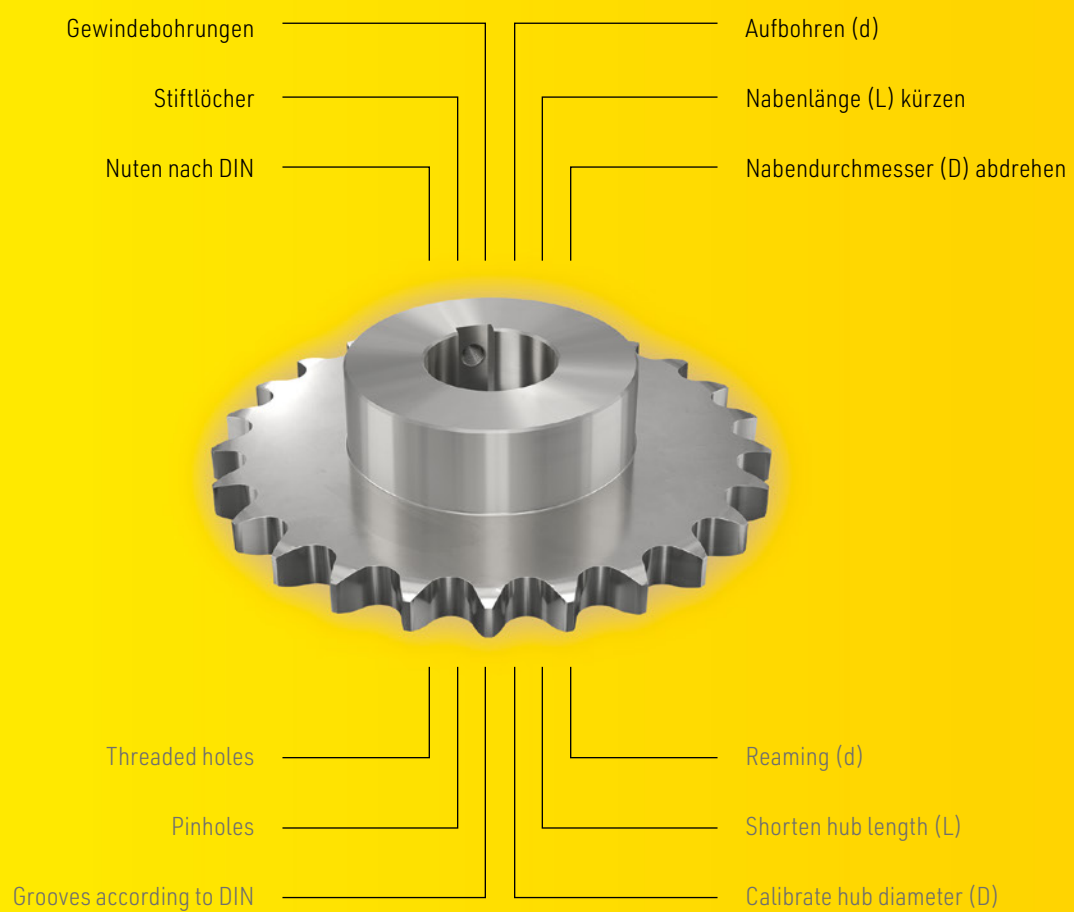

## Machining range

# KETTENRÄDER UND KETTENRADSCHLEIBEN

---

Mehr als Standard

Unser spezielles Individualisierungsprogramm für Kettenräder und Kettenradscheiben bietet die Anpassung an Ihren Bedarf. Verfügbar sind:

- Witra-Kettenräder für Einfach- und Zweifach-Rollenketten
- Witra-Kettenradscheiben für Einfach-Rollenketten

In unserem neuen Bearbeitungszentrum können wir flexibel eine Vielzahl von Individualisierungsoptionen an standardisiert vorgebohrten Kettenrädern realisieren. Moderne CNC-Maschinen ermöglichen es uns, verschiedenste Optionen hochexakt und zeitnah umzusetzen.

# SPROCKETS AND PLATE SPROCKETS

---

More than standard

Our special customization program for sprockets and plate sprockets is designed to meet your needs. The range includes:

- Witra sprockets for simplex and duplex roller chains
- Witra plate sprockets for simplex roller chains

Our new machining centre offers the flexibility to realize a wide range of individual options for standardized pre-drilled sprockets. Modern CNC machines enable us to implement a wide range of options in a highly precise and timely manner.



#### Ihr schneller Kontakt zu Witra

Telefon: +49 5223 7633 - 40

E-Mail: [witra@wippermann.com](mailto:witra@wippermann.com)

#### Your quick link to Witra

Phone: +49 5223 7633 - 40

E-Mail: [witra@wippermann.com](mailto:witra@wippermann.com)





# PERFEKTER SERVICE

---

## 24h Lieferung für Lagerware

Das Herzstück des Witra-Standortes in Kirchlengern ist die Logistik: Dank modernster Warenwirtschaft und optimal abgestimmter Prozesse liefern wir lagernde Artikel innerhalb von 24 Stunden zu Ihrem Standort innerhalb Deutschlands.

Auch Individualisierungen Ihrer Ketten oder Kettenräder realisieren wir flexibel und schnell und liefern Ihnen die maßgeschneiderten Komponenten innerhalb weniger Tage.

Testen Sie unsere Qualität und Flexibilität: Wir sind mit großem Engagement für Sie da und realisieren Ihre Wünsche in kürzester Zeit. Sprechen Sie uns an, wir freuen uns auf Ihre Anfrage.

# PERFECT SERVICE

---

## 24h delivery for stock goods

The heart of the Witra site in Kirchlengern is the logistics center: Thanks to modern ERP systems and perfectly coordinated processes, we deliver stock items to your German location within 24 hours.

We can also customize your chains or sprockets quickly and flexibly and deliver the individualized components within a few days.

Test our quality and flexibility: We are 100% dedicated to meeting your requirements in the shortest possible time. Get in touch with us, we look forward to your request.

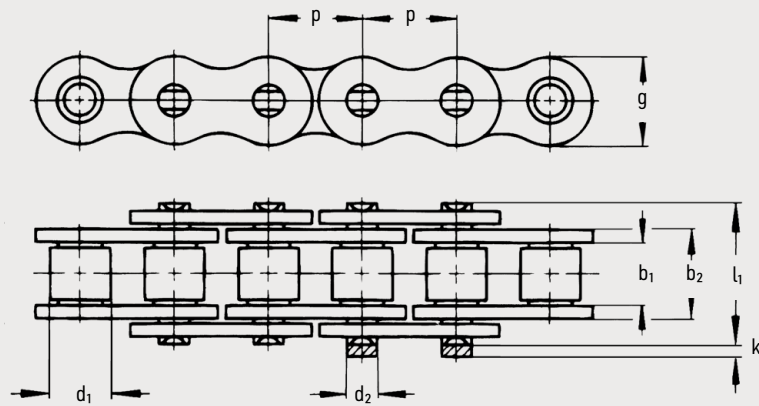

Verschlussseite / Connecting side

WITRA®		ISO	Teilung		Innere Breite	Innengliedbreite	Rollen-Ø	Bolzen-Ø	Laschenhöhe	Überstand	Maß über Bolzen	Gelenkfläche	Bruchkraft ISO	Gewicht	Verbindungsglieder
			Pitch		Inner width	Inner link width	Roller-Ø	Pin-Ø	Plate height	Project. over conn. link	Width over pin	Bearing area	Breaking load ISO	Weight	Connecting links
			p		b <sub>1</sub> min.	b <sub>2</sub> max.	d <sub>1</sub> max.	d <sub>2</sub> max.	g max.	k max.	l <sub>1</sub> max.	f	F <sub>B</sub> min.	q ≈	
No.	Ind.	No.	mm	inch	mm	mm	mm	mm	mm	mm	mm	cm <sup>2</sup>	N	kg/m	Type
WT 04		04	6,000	-	2,80	4,10	4,00	1,85	5,1	2,9	7,4	0,08	3 000	0,11	A, E, C
WT 05		05 B-1	8,000	-	3,00	4,77	5,00	2,31	7,1	3,1	8,6	0,11	4 400	0,18	A, E, C
WT 06	1	06 B-1	9,525	3/8	5,72	8,53	6,35	3,28	8,2	3,3	13,5	0,28	8 900	0,39	A, E, L, C
WT 08		08 B-1	12,700	1/2	7,75	11,30	8,51	4,45	11,8	3,9	17,0	0,50	17 800	0,68	A, E, L, C
WT 08	2	08 B-1	12,700	1/2	7,75	11,30	8,51	4,45	11,8	3,9	31,0	0,50	17 800	0,75	A, E, L
WT 081		081	12,700	1/2	3,30	5,80	7,75	3,66	9,9	1,5	10,2	0,21	8 000	0,28	A, E, L, C
WT 083		083	12,700	1/2	4,88	7,90	7,75	4,09	10,3	1,5	12,9	0,32	11 600	0,42	A, E, L
WT 084		084	12,700	1/2	4,88	8,80	7,75	4,09	11,1	1,5	14,8	0,36	15 600	0,59	A, E
WT 10		10 B-1	15,875	5/8	9,65	13,28	10,16	5,08	14,7	4,1	19,6	0,67	22 200	0,91	A, E, S, L, C
WT 12		12 B-1	19,050	3/4	11,68	15,62	12,07	5,72	16,1	4,6	22,7	0,89	28 900	1,12	A, E, S, L, C
WT 12-H		-	19,050	3/4	11,68	17,00	12,07	6,05	18,1	3,6	24,8	1,05	40 000	1,51	A, E, S, L
WT 16		16 B-1	25,400	1	17,02	25,45	15,88	8,28	21,0	5,4	36,1	2,10	60 000	2,64	A, E, S, L, C
WT 16-H		-	25,400	1	17,02	25,45	15,88	8,90	24,1	5,4	36,1	2,23	80 000	3,11	A, E, L
WT 20		20 B-1	31,750	1 1/4	19,56	29,00	19,05	10,19	26,4	6,1	43,2	2,96	95 000	3,68	A, E, S, L, C
WT 24		24 B-1	38,100	1 1/2	25,40	37,90	25,40	14,63	33,4	6,6	53,4	5,54	160 000	7,16	A, S, L, C
WT 28		28 B-1	44,450	1 3/4	30,99	46,58	27,94	15,90	37,0	7,4	65,1	7,39	200 000	7,53	A, S, L, C
WT 32		32 B-1	50,800	2	30,99	45,57	29,21	17,81	42,3	7,9	67,4	8,10	250 000	9,84	A, S, L, C
WT 40		40 B-1	63,500	2 1/2	38,10	55,75	39,37	22,89	52,9	10,2	82,6	12,75	355 000	16,99	A, S, L
WT 48		48 B-1	76,200	3	45,72	70,56	48,26	29,24	63,9	10,5	99,1	20,61	560 000	23,92	A, S, L
WT 56		56 B-1	88,900	3 1/2	53,34	81,30	53,98	34,32	77,9	11,7	114,6	27,90	850 000	35,78	A, S

<sup>1</sup> nur mit geraden Laschen / <sup>1</sup> with straight side plates only <sup>2</sup> jeder 2. Bolzen als Duplexbolzen einseitig überstehend / <sup>2</sup> every second pin as one-side duplex pin

Verbindungsglieder / Connecting links



**A**  
Außenglied (Nietglied)

Pin link



**E**  
Verbindungsglied mit Feder

Spring Connecting link



**S**  
Verbindungsglied mit Splinten

Cotter pin Connecting link



**L**  
Gekröpftes Glied mit Splint

Offset link



**C**  
Gekröpftes Doppelglied

Double cranked link

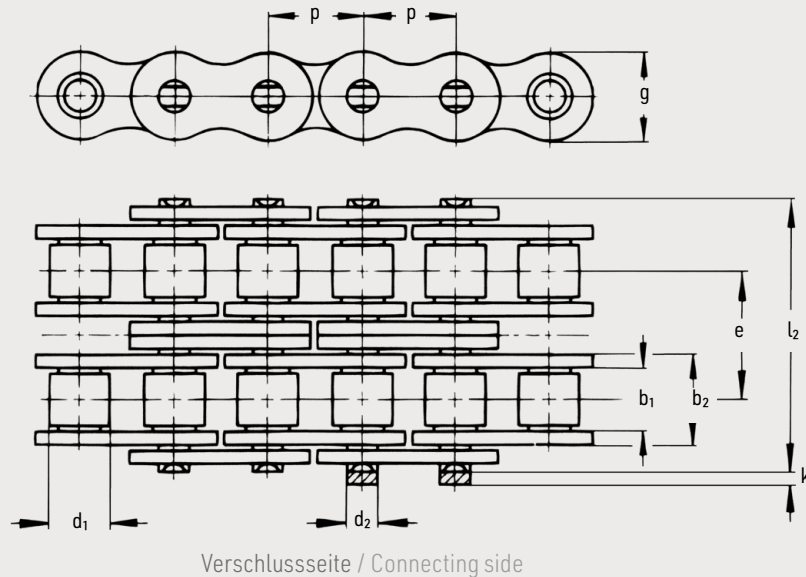

WITRA®		ISO	Teilung		Innere Breite	Innengliedbreite	Roller-Ø	Bolzen-Ø	Quer- teilung	Laschen- höhe	Über- stand	Maß über Bolzen	Gelenk- fläche	Bruchkraft ISO	Gewicht	Verbindungs- glieder
			Pitch		Inner width	Inner link width	Roller- Ø	Pin- Ø	Trans- verse pitch	Plate height	Project. over conn. link	Width over pin	Bear- ing area	Breaking load ISO	Weight	Connecting links
			p		b <sub>1</sub> min.	b <sub>2</sub> max.	d <sub>1</sub> max.	d <sub>2</sub> max.	e	g max.	k max.	l <sub>2</sub> max.	f	F <sub>B</sub> min.	q ≈	Type
No.	Ind.	No.	mm	inch	mm	mm	mm	mm	mm	mm	mm	mm	cm <sup>2</sup>	N	kg/m	
WT 05-D		05 B-2	8,000	-	3,00	4,77	5,00	2,31	5,64	7,1	3,1	14,3	0,22	7 800	0,34	A, E, C
WT 06-D	<sup>1</sup>	06 B-2	9,525	3/8	5,72	8,53	6,35	3,28	10,24	8,2	3,3	23,8	0,56	16 900	0,74	A, E, L, C
WT 08-D		08 B-2	12,700	1/2	7,75	11,30	8,51	4,45	13,92	11,8	3,9	31,0	1,01	31 100	1,35	A, E, L, C
WT 10-D		10 B-2	15,875	5/8	9,65	13,28	10,16	5,08	16,59	14,7	4,1	36,2	1,34	44 500	1,79	A, E, S, L, C
WT 12-D		12 B-2	19,050	3/4	11,68	15,62	12,07	5,72	19,46	16,1	4,6	42,2	1,79	57 800	2,22	A, E, S, L, C
WT 16-D		16 B-2	25,400	1	17,02	25,45	15,88	8,28	31,88	21,0	5,4	68,0	4,21	106 000	5,13	A, E, S, L, C
WT 16-D-H		-	25,400	1	17,02	25,40	15,88	8,90	31,88	24,1	5,4	68,0	4,46	150 000	6,14	A, E, L
WT 20-D		20 B-2	31,750	1 1/4	19,56	29,00	19,05	10,19	36,45	26,4	6,1	79,7	5,91	170 000	7,72	A, E, S, L, C
WT 24-D		24 B-2	38,100	1 1/2	25,40	37,90	25,40	14,63	48,36	33,4	6,6	101,8	11,09	280 000	14,15	A, S, L, C
WT 28-D		28 B-2	44,450	1 3/4	30,99	46,58	27,94	15,90	59,56	37,0	7,4	124,7	14,79	360 000	17,92	A, S, L, C
WT 32-D		32 B-2	50,800	2	30,99	45,57	29,21	17,81	58,55	42,3	7,9	126,0	16,21	450 000	19,68	A, S, L, C
WT 40-D		40 B-2	63,500	2 1/2	38,10	55,75	39,37	22,89	72,29	52,9	10,2	154,9	25,50	630 000	33,61	A, S, L
WT 48-D		48 B-2	76,200	3	45,72	70,56	48,26	29,24	91,21	63,9	10,5	190,4	41,23	1 000 000	47,50	A, S, L
WT 56-D		56 B-2	88,900	3 1/2	53,34	81,30	53,98	34,32	106,60	77,9	11,7	221,2	55,80	1 600 000	71,48	A, S

<sup>1</sup> nur mit geraden Laschen / <sup>1</sup> with straight side plates only

Verbindungslieder / Connecting links



**A**  
Außenglied  
(Nietglied)  
Pin link



**E**  
Verbindungslied  
mit Feder  
Spring  
Connecting link



**S**  
Verbindungslied  
mit Splinten  
Cotter pin  
Connecting link



**L**  
Gekröpftes Glied  
mit Splint  
Offset link



**C**  
Gekröpftes  
Doppelglied  
Double  
cranked link

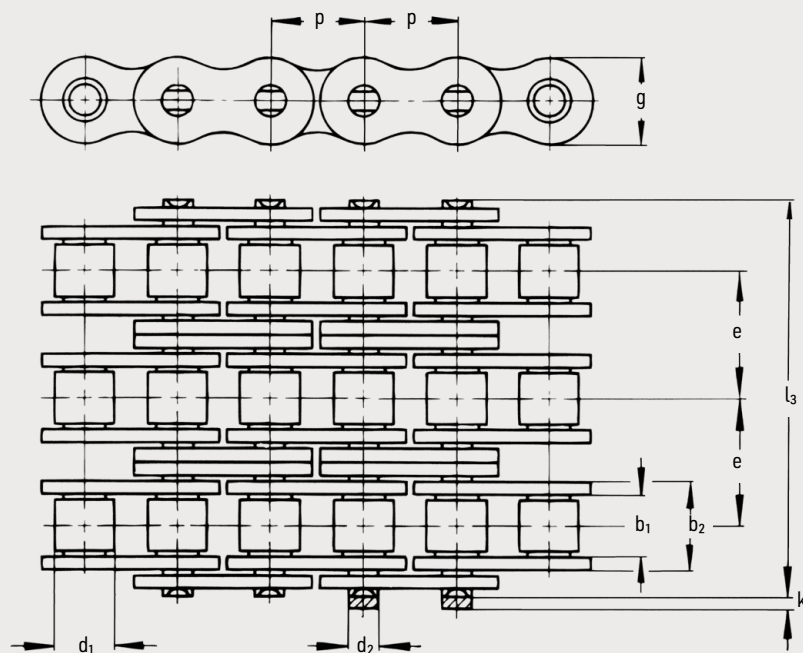

Verschlussseite / Connecting side

WITRA®		ISO	Teilung		Innere Breite	Innengliedbreite	Rollen-Ø	Bolzen-Ø	Quer-teilung	La-schen-höhe	Über-stand	Maß über Bolzen	Gelenk-fläche	Bruchkraft ISO	Gewicht	Verbindungs-glieder
			Pitch		Inner width	Inner link width	Roller-Ø	Pin-Ø	Trans-verse pitch	Plate height	Project. over conn. link	Width over pin	Bea-ring area	Breaking load ISO	Weight	Connecting links
			$p$		$b_1$ min.	$b_2$ max.	$d_1$ max.	$d_2$ max.	$e$	$g$ max.	$k$ max.	$l_3$ max.	$f$	$F_B$ min.	$q$ ≈	
No.	Ind.	No.	mm	inch	mm	mm	mm	mm	mm	mm	mm	mm	cm <sup>2</sup>	N	kg/m	Type
WT 06-T	<sup>1</sup>	06 B-3	9,525	3/8	5,72	8,53	6,35	3,28	10,24	8,2	3,3	34,0	0,81	24 900	1,10	A, E, L, C
WT 08-T		08 B-3	12,700	1/2	7,75	11,30	8,51	4,45	13,92	11,8	3,9	44,9	1,51	44 500	2,03	A, E, L, C
WT 10-T		10 B-3	15,875	5/8	9,65	13,28	10,16	5,08	16,59	14,7	4,1	52,8	2,02	66 700	2,68	A, E, S, L, C
WT 12-T		12 B-3	19,050	3/4	11,68	15,62	12,07	5,72	19,46	16,1	4,6	61,7	2,68	86 700	3,39	A, E, S, L, C
WT 16-T		16 B-3	25,400	1	17,02	25,45	15,88	8,28	31,88	21,0	5,4	99,9	6,31	160 000	7,80	A, E, S, L, C
WT-C 16-T	<sup>1</sup>	C 16 B-3	25,400	1	17,02	25,45	15,88	8,28	31,88	21,0	5,4	99,9	6,31	160 000	8,45	A, E, S, L, C
WT 20-T		20 B-3	31,750	1 1/4	19,56	29,00	19,05	10,19	36,45	26,4	6,1	116,1	8,87	250 000	11,53	A, S, L, C
WT 24-T		24 B-3	38,100	1 1/2	25,40	37,90	25,40	14,63	48,36	33,4	6,6	150,2	16,63	425 000	21,15	A, S, L, C
WT 28-T		28 B-3	44,450	1 3/4	30,99	46,58	27,94	15,90	59,56	37,0	7,4	184,0	22,18	530 000	22,39	A, S, L, C
WT 32-T		32 B-3	50,800	2	30,99	45,57	29,21	17,81	58,55	42,3	7,9	184,5	24,31	670 000	29,52	A, S, L, C
WT 40-T		40 B-3	63,500	2 1/2	38,10	55,75	39,37	22,89	72,29	52,9	10,2	227,2	38,25	950 000	50,23	A, S, L
WT 48-T		48 B-3	76,200	3	45,72	70,56	48,26	29,24	91,21	63,9	10,5	281,6	61,84	1 500 000	71,07	A, S, L
WT 56-T		56 B-3	88,900	3 1/2	53,34	81,30	53,98	34,32	106,60	77,9	11,7	327,8	83,70	2 240 000	107,18	A, S

<sup>1</sup> nur mit geraden Laschen / <sup>1</sup> with straight side plates only

Verbindungsglieder / Connecting links



A Außenglied (Nietglied)

Pin link

E Verbindungsglied mit Feder

Spring Connecting link

S Verbindungsglied mit Splinten

Cotter pin Connecting link

L Gekröpftes Glied mit Splint

Offset link

C Gekröpftes Doppelglied

Double cranked link



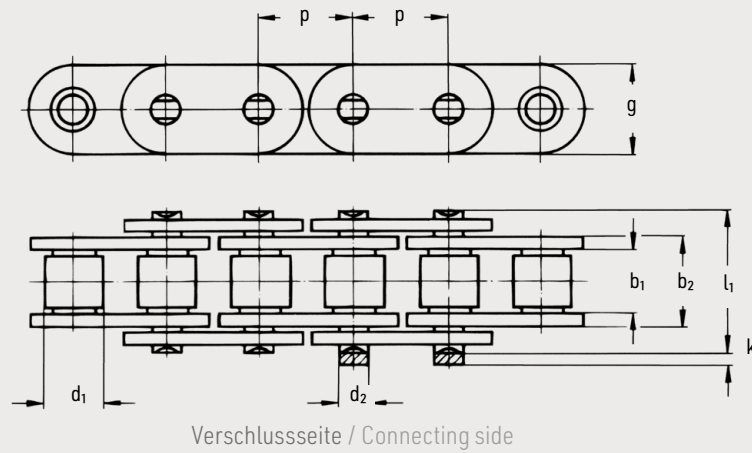

WITRA®	ISO	Teilung		Innere Breite	Innen-glied-breite	Rollen-Ø	Bolzen-Ø	Laschen-höhe	Über-stand	Maß über Bolzen	Gelenk-fläche	Bruchkraft ISO	Gewicht	Verbindungs-glieder
		Pitch												
		p		b <sub>1</sub> min.	b <sub>2</sub> max.	d <sub>1</sub> max.	d <sub>2</sub> max.	g max.	k max.	l <sub>1</sub> max.	f	F <sub>B</sub> min.	q ≈	Connecting links
No.	No.	mm	inch	mm	mm	mm	mm	mm	mm	mm	cm <sup>2</sup>	N	kg/m	Type
<b>WTC 06</b>	C 06 B-1	9,525	3/8	5,72	8,53	6,35	3,28	8,2	3,3	13,5	0,28	8 900	0,41	A, E, L, C
<b>WTC 08</b>	C 08 B-1	12,700	1/2	7,75	11,30	8,51	4,45	11,8	3,9	17,0	0,50	17 800	0,75	A, E, L
<b>WTC 10</b>	C 10 B-1	15,875	5/8	9,65	13,28	10,16	5,08	14,7	4,1	19,6	0,67	22 200	1,03	A, E, L
<b>WTC 12</b>	C 12 B-1	19,050	3/4	11,68	15,62	12,07	5,72	16,1	4,6	22,7	0,89	28 900	1,31	A, E, L
<b>WTC 16</b>	C 16 B-1	25,400	1	17,02	25,45	15,88	8,28	21,0	5,4	36,1	2,10	60 000	2,86	A, E, S, L
<b>WTC 16/24</b>	-	25,400	1	17,02	25,40	15,88	8,28	24,0	5,4	36,1	2,10	60 000	3,25	A, E
<b>WTC 20</b>	C 20 B-1	31,750	1 1/4	19,56	29,00	19,05	10,19	26,4	6,1	43,2	2,96	95 000	4,03	A, E, S, L
<b>WTC 24</b>	C 24 B-1	38,100	1 1/2	25,40	37,90	25,40	14,63	33,4	6,6	53,4	5,54	160 000	7,40	A, S, L
<b>WTC 32</b>	C 32 B-1	50,800	2	30,99	45,57	29,21	17,81	42,3	7,9	67,4	8,10	250 000	10,20	A, S, L

Verbindungsglieder / Connecting links



**A**  
Außenglied (Nietglied)  
Pin link



**E**  
Verbindungsglied mit Feder  
Spring Connecting link



**S**  
Verbindungsglied mit Splinten  
Cotter pin Connecting link



**L**  
Gekröpftes Glied mit Splint  
Offset link

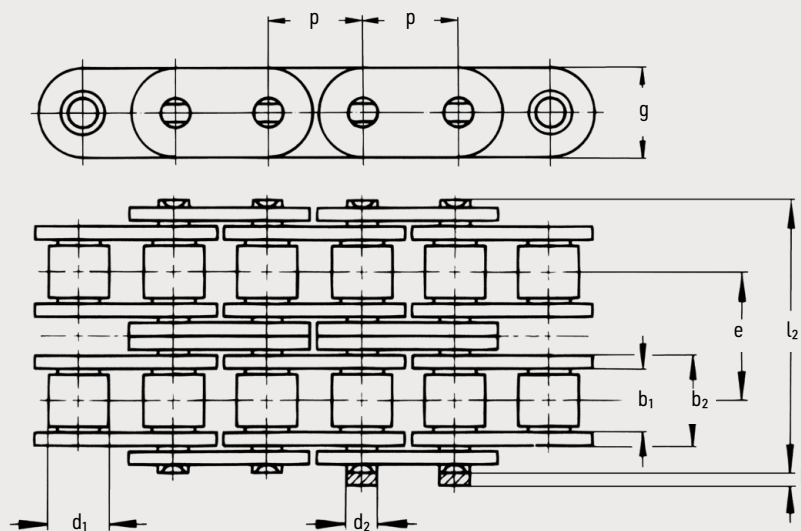

Verschlussseite / Connecting side

WITRA®	ISO	Teilung		Innere Breite	Innengliedbreite	Rollen- $\emptyset$	Bolzen- $\emptyset$	Quer- teilung	La- schen- höhe	Über- stand	Maß über Bolzen	Gelenk- fläche	Bruchkraft ISO	Gewicht	Verbindungs- glieder
		Pitch		Inner width	Inner link width	Roller- $\emptyset$	Pin- $\emptyset$	Trans- verse pitch	Plate height	Project. over conn. link	Width over pin	Bea- ring area	Breaking load ISO	Weight	Connecting links
		$p$		$b_1$ min.	$b_2$ max.	$d_1$ max.	$d_2$ max.	$e$	$g$ max.	$k$ max.	$l_2$ max.	$f$	$F_B$ min.	$q$ $\approx$	
No.	No.	mm	inch	mm	mm	mm	mm	mm	mm	mm	mm	cm <sup>2</sup>	N	kg/m	Type
WTC 06-D	C 06 B-2	9,525	3/8	5,72	8,53	6,35	3,28	10,24	8,2	3,3	23,8	0,56	16 900	0,74	A, E, L
WTC 08-D	C 08 B-2	12,700	1/2	7,75	11,30	8,51	4,45	13,92	11,8	3,9	31,0	1,01	31 100	1,48	A, E, L
WTC 10-D	C 10 B-2	15,875	5/8	9,65	13,28	10,16	5,08	16,59	14,7	4,1	36,2	1,34	44 500	2,04	A, E, L
WTC 12-D	C 12 B-2	19,050	3/4	11,68	15,62	12,07	5,72	19,46	16,1	4,6	42,2	1,79	57 800	2,54	A, E, S, L
WTC 16-D	C 16 B-2	25,400	1	17,02	25,45	15,88	8,28	31,88	21,0	5,4	68,0	4,21	106 000	5,65	A, E, S, L
WTC 20-D	C 20 B-2	31,750	1 1/4	19,56	29,00	19,05	10,19	36,45	26,4	6,1	79,7	5,91	170 000	8,00	A, E, S, L
WTC 24-D	C 24 B-2	38,100	1 1/2	25,40	37,90	25,40	14,63	48,36	33,4	6,6	101,8	11,09	280 000	14,55	A, S, L
WTC 32-D	C 32 B-2	50,800	2	30,99	45,57	29,21	17,81	58,55	42,3	7,9	126,0	16,21	450 000	20,47	A, S, L

Verbindungsglieder / Connecting links



**A**  
 Außenglied  
 (Nietglied)  
 Pin link



**E**  
 Verbindungsglied  
 mit Feder  
 Spring  
 Connecting link



**S**  
 Verbindungsglied  
 mit Splinten  
 Cotter pin  
 Connecting link



**L**  
 Gekröpftes Glied  
 mit Splint  
 Offset link

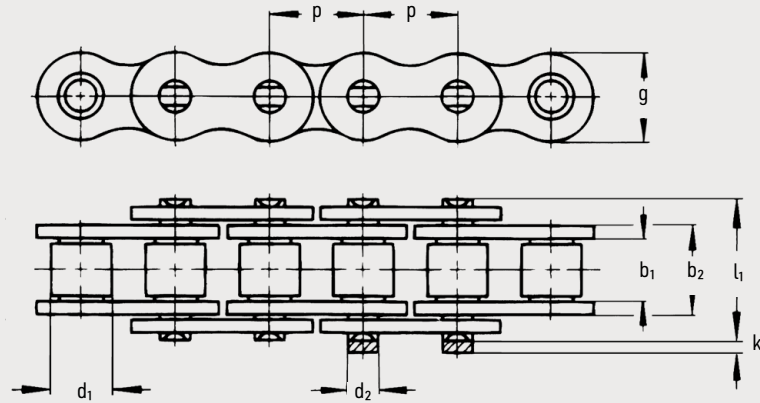

Verschlussseite / Connecting side

WITRA®		ISO	Teilung		Innere Breite	Innengliedbreite	Rollen-Ø	Bolzen-Ø	Laschenhöhe	Überstand	Maß über Bolzen	Gelenkfläche	Bruchkraft ISO	Gewicht	Verbindungsglieder
			Pitch		Inner width	Inner link width	Roller-Ø	Pin-Ø	Plate height	Project. over conn. link	Width over pin	Bearing area	Breaking load ISO	Weight	Connecting links
			p		b <sub>1</sub> min.	b <sub>2</sub> max.	d <sub>1</sub> max.	d <sub>2</sub> max.	g max.	k max.	l <sub>1</sub> max.	f	F <sub>B</sub> min.	q ≈	Type
No.	Ind.	No.	mm	inch	mm	mm	mm	mm	mm	mm	mm	cm <sup>2</sup>	N	kg/m	Type
WTASA 40		08 A-1	12,700	1/2	7,85	11,17	7,92	3,98	12,0	3,9	17,8	0,44	13 900	0,60	A, E, L, C
WTASA 50		10 A-1	15,875	5/8	9,40	13,80	10,16	5,08	15,0	4,1	21,8	0,70	21 800	1,04	A, E, L, C
WTASA 60		12 A-1	19,050	3/4	12,57	17,70	11,91	5,96	18,1	4,6	26,9	1,05	31 300	1,52	A, E, S, L
WTASA 60-GL	<sup>1</sup>	C12 A-1	19,050	3/4	12,57	17,70	11,91	5,96	18,1	4,6	26,9	1,05	31 300	1,58	A, E, L
WTASA 80		16 A-1	25,400	1	15,75	22,60	15,88	7,94	24,1	5,4	33,5	1,78	55 600	2,60	A, E, S, L, C
WTASA 100		20 A-1	31,750	1 1/4	18,90	27,45	19,05	9,54	30,1	6,1	41,1	2,61	87 000	4,01	A, S, L
WTASA 120		24 A-1	38,100	1 1/2	25,22	35,45	22,23	11,11	36,2	6,6	50,8	3,92	125 000	5,74	A, S, L
WTASA 140		28 A-1	44,450	1 3/4	25,22	37,18	25,40	12,71	42,2	7,4	54,9	4,70	170 000	7,66	A, S, L
WTASA 160		32 A-1	50,800	2	31,55	45,21	28,58	14,29	48,2	7,9	65,5	6,42	223 000	9,84	A, S, L

<sup>1</sup> nur mit geraden Laschen / <sup>1</sup> with straight side plates only

Verbindungsglieder / Connecting links



**A**  
Außenglied (Nietglied)

Pin link



**E**  
Verbindungsglied mit Feder

Spring Connecting link



**S**  
Verbindungsglied mit Splint

Cotter pin Connecting link



**L**  
Gekröpftes Glied mit Splint

Offset link



**C**  
Gekröpftes Doppelglied

Double cranked link

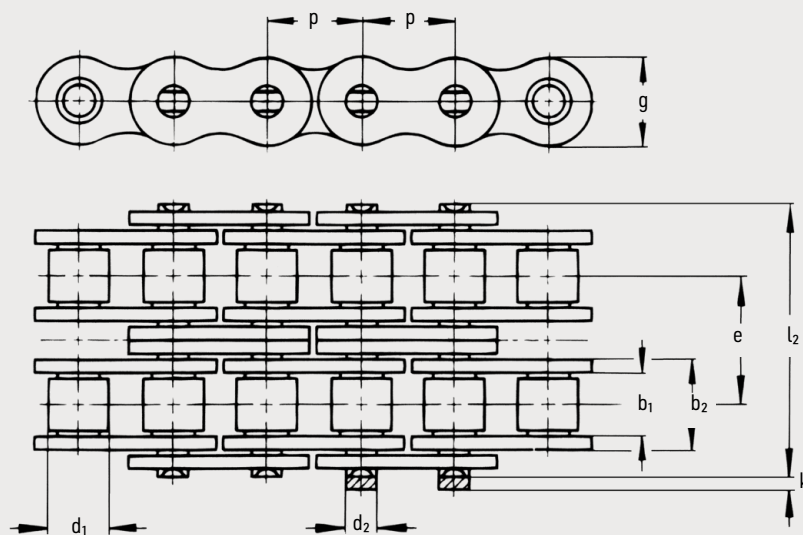

Verschlussseite / Connecting side

WITRA®	ISO	Teilung		Innere Breite	Innengliedbreite	Rollen-Ø	Bolzen-Ø	Quer- teilung	La- schen- höhe	Über- stand	Maß über Bolzen	Gelenk- fläche	Bruchkraft ISO	Gewicht	Verbindungs- glieder
		Pitch		Inner width	Inner link width	Roller- Ø	Pin- Ø	Trans- verse pitch	Plate height	Project. over conn. link	Width over pin	Bear- ing area	Breaking load ISO	Weight	Connecting links
		p		b <sub>1</sub> min.	b <sub>2</sub> max.	d <sub>1</sub> max.	d <sub>2</sub> max.	e	g max.	k max.	l <sub>2</sub> max.	f	F <sub>B</sub> min.	q ≈	
No.	No.	mm	inch	mm	mm	mm	mm	mm	mm	mm	mm	cm <sup>2</sup>	N	kg/m	Type
WT ASA 40-D	08 A-2	12,700	1/2	7,85	11,17	7,92	3,98	14,38	12,0	3,9	32,3	0,88	27 800	1,20	A, E, L, C
WT ASA 50-D	10 A-2	15,875	5/8	9,40	13,80	10,16	5,08	18,11	15,0	4,1	39,9	1,40	43 600	1,78	A, E, L, C
WT ASA 60-D	12 A-2	19,050	3/4	12,57	17,70	11,91	5,96	22,78	18,1	4,6	49,8	2,10	62 600	3,01	A, E, L, C
WT ASA 80-D	16 A-2	25,400	1	15,75	22,60	15,88	7,94	29,29	24,1	5,4	62,7	3,56	111 200	5,15	A, E, L, C
WT ASA 100-D	20 A-2	31,750	1 1/4	18,90	27,45	19,05	9,54	35,76	30,1	6,1	77,0	5,22	174 000	7,93	A, S, L
WT ASA 120-D	24 A-2	38,100	1 1/2	25,22	35,45	22,23	11,11	45,44	36,2	6,6	96,3	7,84	250 000	11,37	A, S, L
WT ASA 140-D	28 A-2	44,450	1 3/4	25,22	37,18	25,40	12,71	48,87	42,2	7,4	103,6	9,40	340 000	15,36	A, S, L
WT ASA 160-D	32 A-2	50,800	2	31,55	45,21	28,58	14,29	58,55	48,2	7,9	124,2	12,84	446 000	19,53	A, S, L

## Verbindungsglieder / Connecting links



A

Außenglied  
(Nietglied)

Pin link



E

Verbindungsglied  
mit FederSpring  
Connecting link

S

Verbindungsglied  
mit SplintCotter pin  
Connecting link

L

Gekröpftes Glied  
mit Splint

Offset link



C

Gekröpftes  
DoppelgliedDouble  
cranked link



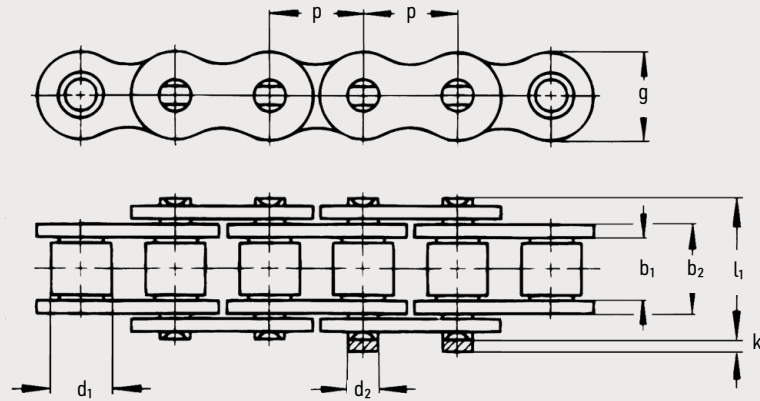

Verschlussseite / Connecting side

WITRA®		Teilung		Innere Breite	Innengliedbreite	Rollen-Ø	Bolzen-Ø	Laschenhöhe	Überstand	Maß über Bolzen	Gelenkfläche	Bruchkraft ISO	Gewicht	Verbindungsglieder
		Pitch		Inner width	Inner link width	Roller-Ø	Pin-Ø	Plate height	Project. over conn. link	Width over pin	Bearing area	Breaking load ISO	Weight	Connecting links
		$p$		$b_1$ min.	$b_2$ max.	$d_1$ max.	$d_2$ max.	$g$ max.	$k$ max.	$l_1$ max.	$f$	$F_B$ min.	$q$ ≈	
No.	Ind.	mm	inch	mm	mm	mm	mm	mm	mm	mm	cm <sup>2</sup>	N	kg/m	Type
WTASA 50-H		15,875	5/8	9,40	14,24	10,16	5,09	15,0	4,1	22,1	0,74	22 200	1,25	A, E, L
WTASA 60-H		19,050	3/4	12,57	19,43	11,91	5,96	18,1	4,6	30,2	1,16	31 300	1,81	A, E, L
WTASA 80-H		25,400	1	15,75	24,28	15,88	7,94	24,1	5,4	37,4	1,92	55 600	3,00	A, E, L
WTASA 100-H		31,750	1 1/4	18,90	29,10	19,05	9,54	30,1	6,1	44,5	2,77	87 000	4,38	A, S, L
WTASA 120-H		38,100	1 1/2	25,22	37,18	22,23	11,11	36,2	6,6	55,0	4,13	125 000	6,61	A, S, L
WTASA 140-H		44,450	1 3/4	25,22	38,86	25,40	12,71	42,2	7,4	59,0	4,94	170 000	8,33	A, S, L
WTASA 60-HGL	<sup>1</sup>	19,050	3/4	12,57	19,43	11,91	5,96	18,1	4,6	30,2	1,16	31 300	1,81	A, E, L
WTASA 80-HGL	<sup>1</sup>	25,400	1	15,75	24,28	15,88	7,94	24,1	5,4	37,4	1,92	55 600	3,00	A, E, L

<sup>1</sup> nur mit geraden Laschen / <sup>1</sup> with straight side plates only

Verbindungsglieder / Connecting links



**A**  
Außenglied (Nietglied)

Pin link



**E**  
Verbindungsglied mit Feder

Spring Connecting link



**S**  
Verbindungsglied mit Splinten

Cotter pin Connecting link



**L**  
Gekröpftes Glied mit Splint

Offset link

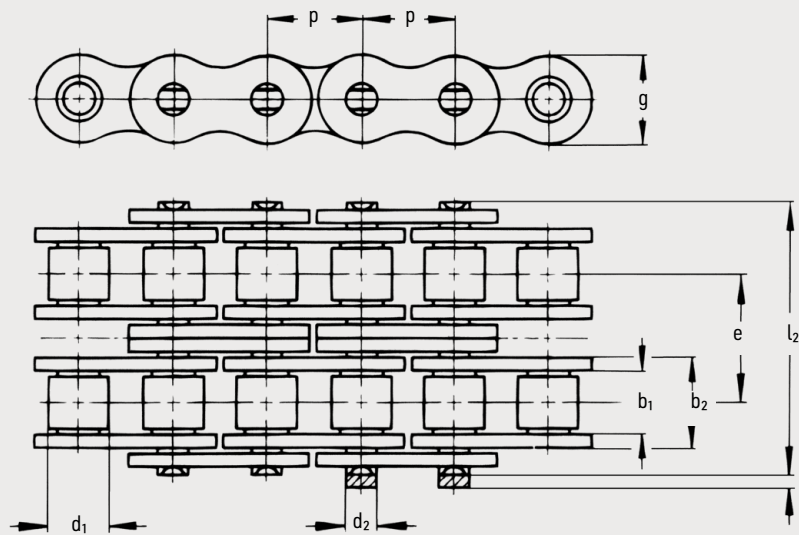

Verschlussseite / Connecting side

WITRA®	Teilung		Innere Breite	Innengliedbreite	Rollen-Ø	Bolzen-Ø	Quer- teilung	Laschen- höhe	Über- stand	Maß über Bolzen	Gelenk- fläche	Bruchkraft ISO	Gewicht	Verbindungs- glieder
	Pitch		Inner width	Inner link width	Roller- Ø	Pin- Ø	Trans- verse pitch	Plate height	Project. over conn. link	Width over pin	Bear- ing area	Breaking load ISO	Weight	Connecting links
	p		b <sub>1</sub> min.	b <sub>2</sub> max.	d <sub>1</sub> max.	d <sub>2</sub> max.	e	g max.	k max.	l <sub>2</sub> max.	f	F <sub>B</sub> min.	q ≈	Type
No.	mm	inch	mm	mm	mm	mm	mm	mm	mm	mm	cm <sup>2</sup>	N	kg/m	Type
WTASA 60-H-2	19,050	¾	12,57	19,43	11,91	5,96	26,11	18,1	4,6	56,3	2,27	62 600	3,71	A, E, L
WTASA 80-H-2	25,400	1	15,75	24,28	15,88	7,94	32,59	24,1	5,4	70,0	3,79	112 200	5,93	A, E, L
WTASA100-H-2	31,750	1 ¼	18,90	29,10	19,05	9,54	39,09	30,2	6,1	83,6	5,50	174 000	8,67	A, S, L
WTASA120-H-2	38,100	1 ½	25,22	37,18	22,23	11,11	48,87	36,2	6,6	103,9	8,20	250 000	13,13	A, S, L
WTASA140-H-2	44,450	1 ¾	25,22	38,86	25,40	12,71	52,20	42,2	7,4	111,2	9,35	340 000	16,51	A, S, L

Verbindungsglieder / Connecting links



**A**  
Außenglied  
(Nietglied)

Pin link



**E**  
Verbindungsglied  
mit Feder

Spring  
Connecting link



**S**  
Verbindungsglied  
mit Splinten

Cotter pin  
Connecting link



**L**  
Gekröpftes Glied  
mit Splint

Offset link

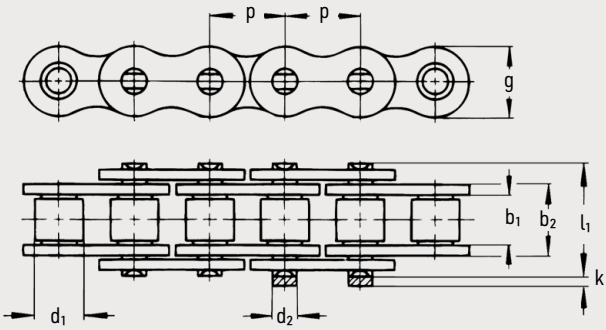

Verschlussseite / Connecting side

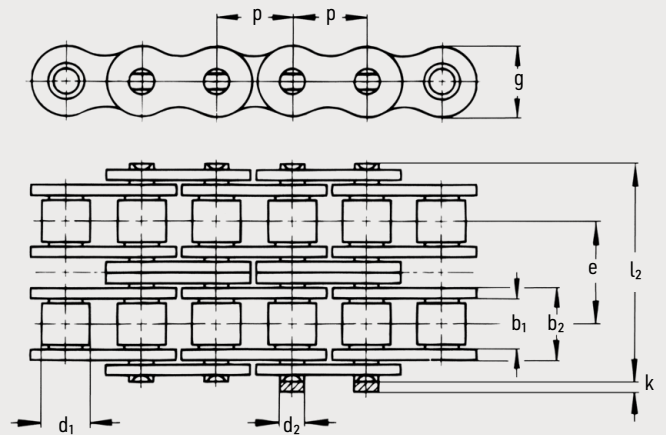

Verschlussseite / Connecting side

WITRA®		ISO	Teilung		Innere Breite	Innengliedbreite	Roller-Ø	Bolzen-Ø	Quer- teilung	Laschen- höhe	Über- stand	Maß über Bolzen	Gelenk- fläche	Bruch- kraft ISO	Gewicht	Verbindungs- glieder
			Pitch		Inner width	Inner link width	Roller- Ø	Pin- Ø	Trans- verse pitch	Plate height	Project. over conn. link	Width over pin	Bea- ring area	Breaking load ISO	Weight	Connecting links
			p		b <sub>1</sub> min.	b <sub>2</sub> max.	d <sub>1</sub> max.	d <sub>2</sub> max.	e	g max.	k max.	l max.	f	F <sub>B</sub> min.	q ≈	
No.	Ind.	No.	mm	inch	mm	mm	mm	mm	mm	mm	mm	mm	cm <sup>2</sup>	N	kg/m	Type
WT 05 SS		05 B-1	8,000	-	3,00	4,77	5,00	2,31	-	7,1	3,1	8,6	0,11	4 000	0,18	A, E, C
WT 06 SS		06 B-1	9,525	3/8	5,72	8,53	6,35	3,28	-	8,2	3,3	13,5	0,28	7 000	0,41	A, E, L, C
WT 08 SS		08 B-1	12,700	1/2	7,75	11,30	8,51	4,45	-	11,8	3,9	17,0	0,50	12 000	0,68	A, E, L, C
WT 10 SS		10 B-1	15,875	5/8	9,65	13,28	10,16	5,08	-	14,7	4,1	19,6	0,67	14 500	0,91	A, E, L, C
WT 12 SS		12 B-1	19,050	3/4	11,68	15,62	12,07	5,72	-	16,1	4,6	22,7	0,89	18 500	1,12	A, E, L, C
WT 16 SS		16 B-1	25,400	1	17,02	25,45	15,88	8,28	-	21,0	5,4	36,1	2,10	40 000	2,64	A, E, S, L, C
WT 06-D SS		06 B-2	9,525	3/8	5,72	8,53	6,35	3,28	10,24	8,2	3,3	23,8	0,56	11 900	0,78	A, E, L, C
WT 08-D SS		08 B-2	12,700	1/2	7,75	11,30	8,51	4,45	13,92	11,8	3,9	31,0	1,00	20 400	1,35	A, E, L, C
WT 10-D SS		10 B-2	15,875	5/8	9,65	13,28	10,16	5,08	16,59	14,7	4,1	36,2	1,34	24 650	1,79	A, E, L, C
WT 12-D SS		12 B-2	19,050	3/4	11,68	15,62	12,07	5,72	19,46	16,1	4,6	42,2	1,79	31 450	2,22	A, E, L, C
WT 16-D SS		16 B-2	25,400	1	17,02	25,45	15,88	8,28	31,88	21,0	5,4	68,0	4,21	68 000	5,13	A, E, S, L, C

Einfach Rollenkettens Reihe C „rostfrei“ (gerade Laschen)  
 Simplex roller chains with straight side plates „stainless steel“

WTC 08 SS	<sup>3</sup>	C 08 B-1	12,700	1/2	7,75	11,30	8,51	4,45	-	11,8	3,9	17,0	0,50	12 000	0,78	A, E, L
WTC 10 SS	<sup>3</sup>	C 10 B-1	15,875	5/8	9,65	13,28	10,16	5,08	-	14,7	4,1	19,6	0,67	15 000	1,02	A, E, L
WTC 12 SS	<sup>3</sup>	C 12 B-1	19,050	3/4	11,68	15,62	12,07	5,72	-	16,1	4,6	22,7	0,89	17 000	1,27	A, E, L
WTC 16 SS	<sup>3</sup>	C 16 B-1	25,400	1	17,02	25,45	15,88	8,28	-	21,0	5,4	36,1	2,10	40 000	2,95	A, E, L, S
WTC 16 SS/24	<sup>3</sup>	-	25,400	1	17,02	25,45	15,88	8,28	-	24,0	5,4	36,1	2,10	40 000	3,35	A, E, L, S

<sup>3</sup> auch in Duplex / <sup>3</sup> also available in Duplex

Verbindungsglieder / Connecting links



**A**  
 Außenglied  
 (Nietglied)  
 Pin link

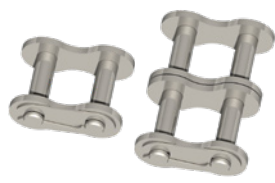

**E**  
 Verbindungsglied  
 mit Feder  
 Spring  
 Connecting link



**L**  
 Gekröpftes Glied  
 mit Splint  
 Offset link

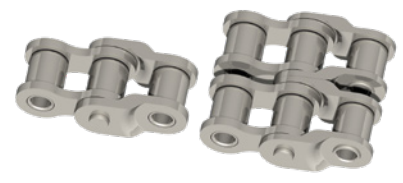

**C**  
 Gekröpftes  
 Doppelglied  
 Double  
 cranked link

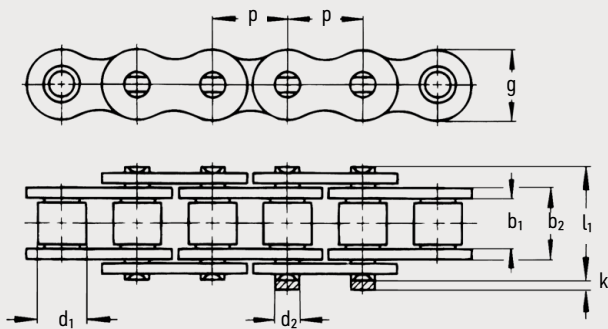

Verschlussseite / Connecting side

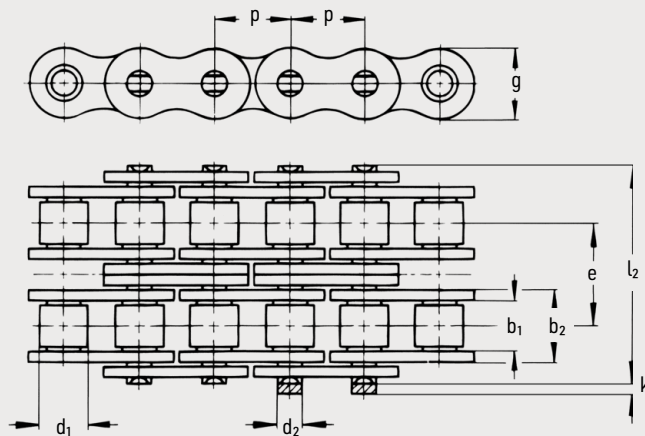

Verschlussseite / Connecting side

WITRA®	ISO	Teilung		Innere Breite	Innengliedbreite	Rollen-Ø	Bolzen-Ø	Quer- teilung	Laschen- höhe	Über- stand	Maß über Bolzen	Gelenk- fläche	Bruchkraft ISO	Gewicht	Verbindungs- glieder
		Pitch		Inner width	Inner link width	Roller- Ø	Pin- Ø	Trans- verse pitch	Plate height	Project. over conn. link	Width over pin	Bea- ring area	Breaking load ISO	Weight	Connecting links
		p		b <sub>1</sub> min.	b <sub>2</sub> max.	d <sub>1</sub> max.	d <sub>2</sub> max.	e	g max.	k max.	l max.	f	F <sub>B</sub> min.	q ≈	
No.	No.	mm	inch	mm	mm	mm	mm	mm	mm	mm	mm	cm <sup>2</sup>	N	kg/m	Type
<b>WT 05 NP</b>	05 B-1	8,000	-	3,00	4,77	5,00	2,31	-	7,1	3,1	8,6	0,11	5 000	0,18	A, E
<b>WT 06 NP</b>	06 B-1	9,525	3/8	5,72	8,53	6,35	3,28	-	8,2	3,3	13,5	0,28	8 900	0,39	A, E, L
<b>WT 08 NP</b>	08 B-1	12,700	1/2	7,75	11,30	8,51	4,45	-	11,8	3,9	17,0	0,50	17 800	0,68	A, E, L
<b>WT 10 NP</b>	10 B-1	15,875	5/8	9,65	13,28	10,16	5,08	-	14,7	4,1	19,6	0,67	22 200	0,91	A, E, L
<b>WT 12 NP</b>	12 B-1	19,050	3/4	11,68	15,62	12,07	5,72	-	16,1	4,6	22,7	0,89	28 900	1,12	A, E, L
<b>WT 16 NP</b>	16 B-1	25,400	1	17,02	25,45	15,88	8,28	-	21,0	5,4	36,1	2,10	60 000	2,64	A, E, L
<b>WT 05-D NP</b>	05 B-2	8,000	-	3,00	4,77	5,00	2,31	5,64	7,1	3,1	14,3	0,22	7 800	0,36	A, E
<b>WT 06-D NP</b>	06 B-2	9,525	3/8	5,72	8,53	6,35	3,28	10,24	8,2	3,3	23,8	0,56	16 900	0,74	A, E, L
<b>WT 08-D NP</b>	08 B-2	12,700	1/2	7,75	11,30	8,51	4,45	13,92	11,8	3,9	31,0	1,01	31 100	1,35	A, E, L
<b>WT 10-D NP</b>	10 B-2	15,875	5/8	9,65	13,28	10,16	5,08	16,59	14,7	4,1	36,2	1,34	44 500	1,79	A, E, L
<b>WT 12-D NP</b>	12 B-2	19,050	3/4	11,68	15,62	12,07	5,72	19,46	16,1	4,6	42,2	1,79	57 800	2,22	A, E, L
<b>WT 16-D NP</b>	16 B-2	25,400	1	17,02	25,45	15,88	8,28	31,88	21,0	5,4	68,0	4,21	106 000	5,13	A, E, L

Verbindungsglieder / Connecting links



**A**  
Außenglied  
(Nietglied)  
Pin link

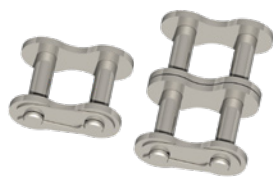

**E**  
Verbindungsglied  
mit Feder  
Spring  
Connecting link



**L**  
Gekröpftes Glied  
mit Splint  
Offset link

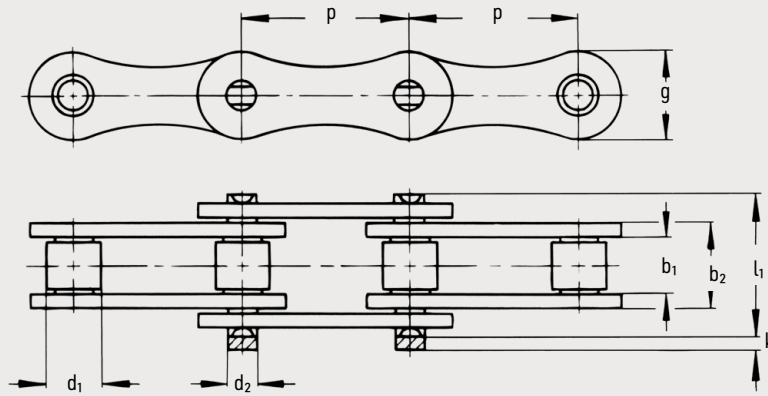

Verschlussseite / Connecting side

WITRA®	ISO	Teilung		Innere Breite	Innengliedbreite	Rollen-Ø	Bolzen-Ø	Laschenhöhe	Überstand	Maß über Bolzen	Gelenkfläche	Bruchkraft ISO	Gewicht	Verbindungsglieder
		Pitch		Inner width	Inner link width	Roller-Ø	Pin-Ø	Plate height	Project. over conn. link	Width over pin	Bearing area	Breaking load ISO	Weight	Connecting links
		p		b <sub>1</sub> min.	b <sub>2</sub> max.	d <sub>1</sub> max.	d <sub>2</sub> max.	g max.	k max.	l <sub>1</sub> max.	f	F <sub>B</sub> min.	q ≈	
No.	No.	mm	inch	mm	mm	mm	mm	mm	mm	mm	cm <sup>2</sup>	N	kg/m	Type
<b>Amerikanische Bauart / American Series</b>														
WT 208-A	208 A	25,400	1	7,85	11,17	7,92	3,98	12,1	3,9	17,8	0,44	13 900	0,49	A, E, S, L
WT 210-A	210 A	31,750	1 ¼	9,40	13,80	10,16	5,09	15,1	4,1	21,8	0,70	21 800	0,64	A, E, S, L
WT 212-A	212 A	38,100	1 ½	12,57	17,75	11,91	5,96	18,1	4,6	26,9	1,05	31 300	1,02	A, E, S, L
WT 216-A	216 A	50,800	2	15,75	22,60	15,88	7,94	24,1	5,4	33,5	1,78	55 600	1,71	A, S, L
WT 220-A	220 A	63,500	2 ½	18,90	27,45	19,05	9,54	30,2	6,1	41,1	2,59	87 000	2,55	A, S, L
<b>Europäische Bauart / European Series</b>														
WT 208-B	208 B	25,400	1	7,75	11,30	8,51	4,45	11,8	3,9	17,0	0,50	17 800	0,46	A, E, S, L
WT 210-B	210 B	31,750	1 ¼	9,65	13,28	10,16	5,08	14,7	4,1	19,6	0,67	22 200	0,57	A, E, S, L
WT 212-B	212 B	38,100	1 ½	11,68	15,62	12,07	5,72	16,1	4,6	22,7	0,89	28 900	0,75	A, E, S, L
WT 216-B	216 B	50,800	2	17,02	25,45	15,88	8,28	21,0	5,4	36,1	2,10	60 000	1,74	A, S, L
WT 220-B	220 B	63,500	2 ½	19,56	29,00	19,05	10,19	26,4	6,1	43,2	2,96	95 000	2,55	A, S, L

Verbindungsglieder / Connecting links



**A**  
Außenglied (Nietglied)  
Pin link



**B**  
Innenglied  
Inner link



**E**  
Verbindungsglied mit Feder  
Spring Connecting link



**S**  
Verbindungsglied mit Splinten  
Cotter pin Connecting link



**L**  
Gekröpftes Glied mit Splint  
Offset link



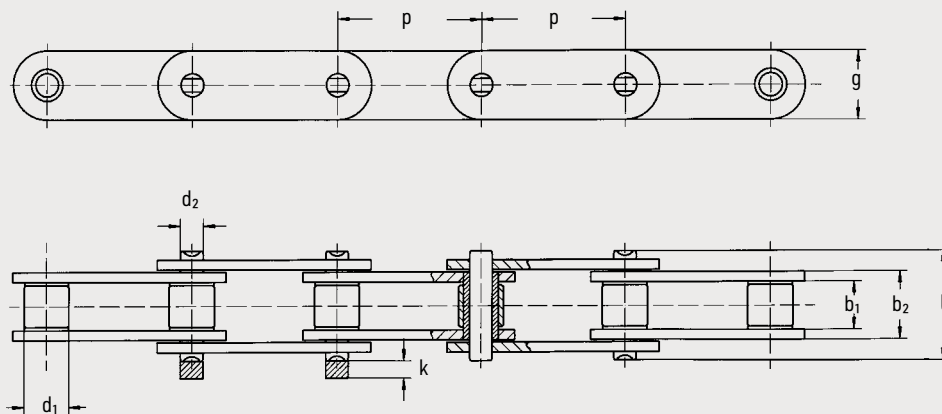

Verschlussseite / Connecting side

WITRA®	ISO	Teilung		Innere Breite	Innengliedbreite	Rollen-Ø	Bolzen-Ø	Laschenhöhe	Überstand	Maß über Bolzen	Gelenkfläche	Bruchkraft ISO	Gewicht	Verbindungs-glieder
		Pitch		Inner width	Inner link width	Roller-Ø	Pin-Ø	Plate height	Project. over conn. link	Width over pin	Bearing area	Breaking load ISO	Weight	Connecting links
		p		b <sub>1</sub> min.	b <sub>2</sub> max.	d <sub>1</sub> max.	d <sub>2</sub> max.	g max.	k max.	l <sub>1</sub> max.	f	F <sub>B</sub> min.	q ≈	
No.	No.	mm	inch	mm	mm	mm	mm	mm	mm	mm	cm <sup>2</sup>	N	kg/m	Type
<b>WTC 2050</b>	C 210 A	31,750	1 ¼	9,40	13,84	10,16	5,09	15,10	4,1	21,8	0,70	21 800	0,81	A, E, S, L
<b>WTC 2060</b>	C 212 A	38,100	1 ½	12,57	17,75	11,91	5,96	18,10	4,6	26,9	1,05	31 300	1,12	A, E, S, L
<b>WTC 2060-H</b>	C 212 A-H	38,100	1 ½	12,57	19,43	11,91	5,96	18,10	4,6	30,2	1,16	31 300	1,44	A, E, S, L
<b>WTC 2080</b>	C 216 A	50,800	2	15,75	22,61	15,88	7,94	24,13	5,4	33,5	1,78	55 600	2,08	A, S, L
<b>WTC 2080-H</b>	C 216 A-H	50,800	2	15,75	24,28	15,88	7,94	24,13	5,4	37,4	1,92	55 600	2,54	A, S, L

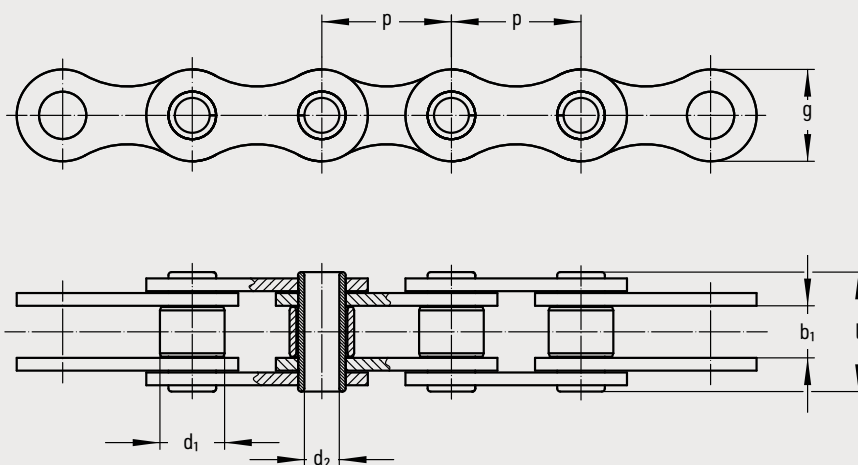

Bauart 1  
Type 1

Verschlussseite / Connecting side

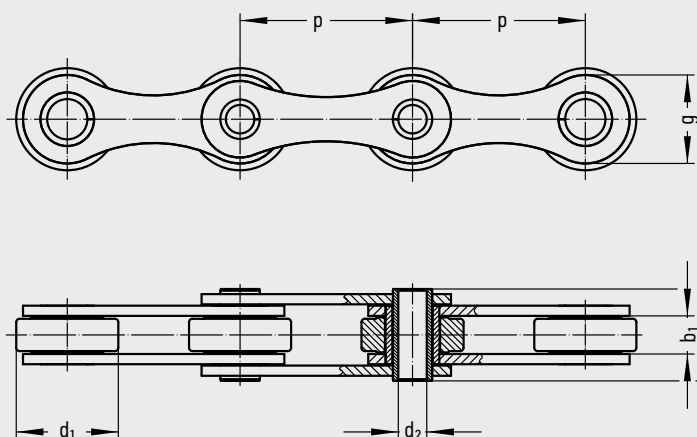

Bauart 2  
Type 2

Verschlussseite / Connecting side

WITRA®	Teilung		Innere Breite	Rollen-Ø	Bohrungs-Ø	Laschenhöhe	Hohlbolzenbreite	Bauart	Gelenkfläche	Bruchkraft DIN	Gewicht
No.	mm	inch	mm	mm	mm	mm	mm	Type	cm <sup>2</sup>	N	kg/m
WT 01463	12,700	1/2	9,50	8,51	4,00	11,8	19,0	1	0,20	14 000	0,68
WT 01650	50,800	2	10,00	30,00	8,20	26,0	27,0	2	1,94	50 000	2,15

Verbindungsglieder mit Sicherungsscheibe / Connecting links circlip type

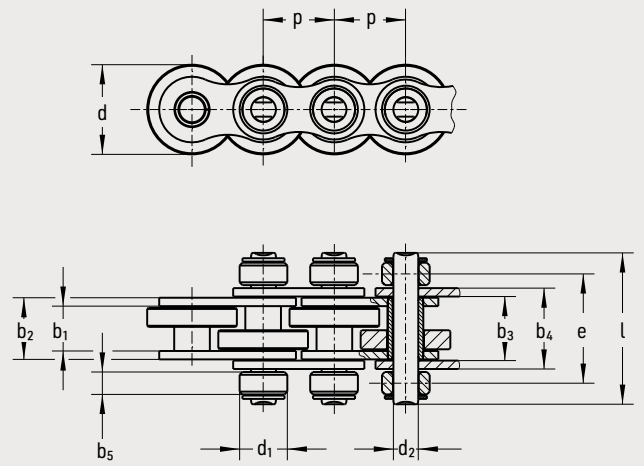
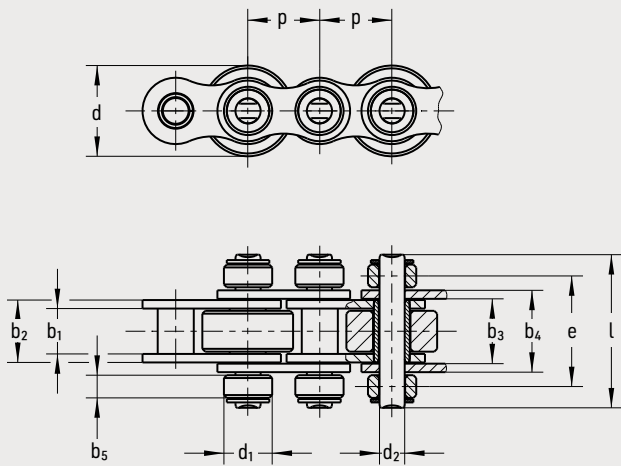

Kette	Teilung	Innere Breite	Innen-glied-breite	Breite		Stütz- rollen- Ø	Bolzen- Ø	Mitten- abstand	Laschen- höhe	Maß über Bolzen	Stütz- rollen- breite	Förder- rollen Ø	Bruch- kraft	Tragfähigkeit pro Rolle	Gewicht
				zwischen Außenlaschen	über outer plates										
Chain	Pitch	Inner width	Inner link width	Width between	Width over	Support roller- Ø	Pin- Ø	Trans- verse pitch	Plate height	Width over pin	Support roller width	Conveyor rolls Ø	Breaking load	Loading capacity per roller	Weight
	p	b <sub>1</sub> min.	b <sub>2</sub> max.	b <sub>3</sub> min.	b <sub>4</sub> max.	d <sub>1</sub>	d <sub>2</sub> max.	e	g max.	l max.	b <sub>5</sub> max.	d	F <sub>B</sub> min.	P	q ≈
No.	mm	mm	mm	mm	mm	mm	mm	mm	mm	mm	mm	mm	kN	kg	kg/m
<b>08 BS 27-C-16</b>	12,700	7,75	11,30	11,43	14,50	8,51	4,45	18,70	11,8	27,00	4,00	16,00	17,80	6	1,23
<b>08 BS327-C-16</b>	12,700	7,75	11,30	11,43	14,50	8,51	4,45	18,70	11,8	27,00	4,00	16,00	17,80	6	1,20

Verbindungsglieder mit Sicherungsscheibe / Connecting links circlip type

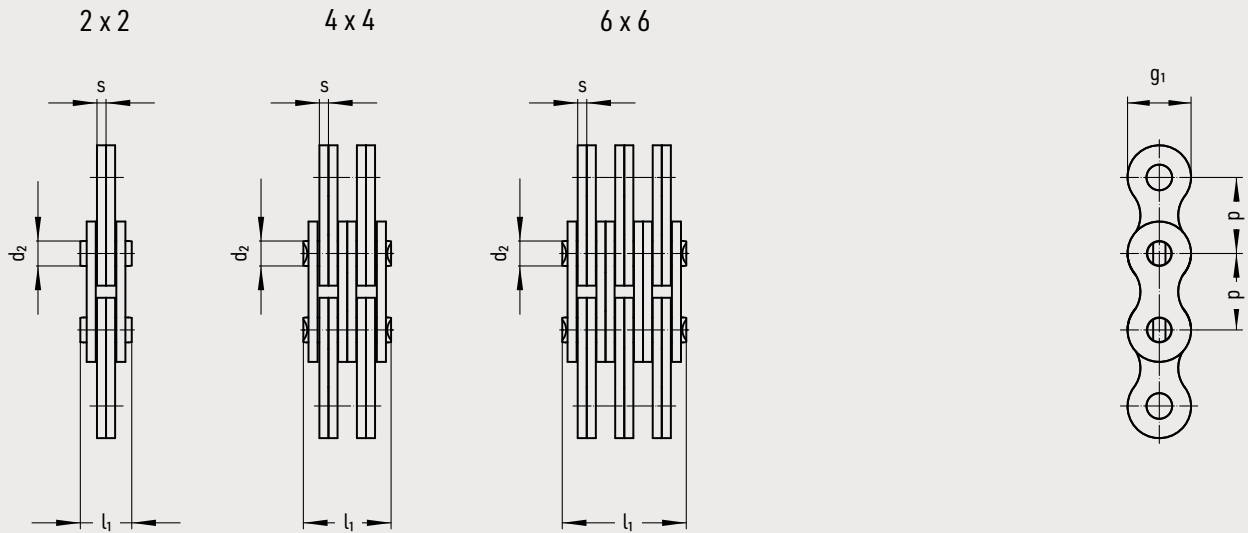

WITRA®	ISO	Nennteilung	Laschen- kombination	Laschenhöhe	Laschendicke	Bolzen- Ø	Breite über Bolzen	Bruchkraft ISO	Gewicht
No.	No.	mm		mm	mm	mm	mm	N	kg/m
WT LL0822	LL0822	12,700	2 x 2	10,9	1,55	4,45	8,5	18 000	0,41
WT LL0844	LL0844	12,700	4 x 4	10,9	1,55	4,45	14,6	36 000	0,69
WT LL0866	LL0866	12,700	6 x 6	14,0	1,55	4,45	20,7	54 000	0,97
WT LL1022	LL1022	15,875	2 x 2	13,7	1,65	5,08	9,3	22 000	0,59
WT LL1044	LL1044	15,875	4 x 4	13,7	1,65	5,08	16,1	44 000	1,13
WT LL1066	LL1066	15,875	6 x 6	13,7	1,65	5,08	22,9	66 000	1,67
WT LL1222	LL1222	19,050	2 x 2	16,1	1,90	5,72	10,7	29 000	0,64
WT LL1244	LL1244	19,050	4 x 4	16,1	1,90	5,72	18,5	58 000	1,26
WT LL1266	LL1266	19,050	6 x 6	16,1	1,90	5,72	26,3	87 000	1,88
WT LL1622	LL1622	25,400	2 x 2	21,1	3,20	8,28	17,2	60 000	1,52
WT LL1644	LL1644	25,400	4 x 4	21,1	3,20	8,28	30,2	120 000	2,98
WT LL1666	LL1666	25,400	6 x 6	21,1	3,20	8,28	43,2	180 000	4,44
WT LL2022	LL2022	31,750	2 x 2	26,4	3,70	10,19	20,1	95 000	2,33
WT LL2044	LL2044	31,750	4 x 4	26,4	3,70	10,19	35,1	190 000	4,56
WT LL2066	LL2066	31,750	6 x 6	26,4	3,70	10,19	50,1	285 000	6,79
WT LL2422	LL2422	38,100	2 x 2	33,4	5,20	14,63	28,4	170 000	4,47
WT LL2444	LL2444	38,100	4 x 4	33,4	5,20	14,63	49,4	340 000	8,67
WT LL2466	LL2466	38,100	6 x 6	33,4	5,20	14,63	70,4	510 000	12,87

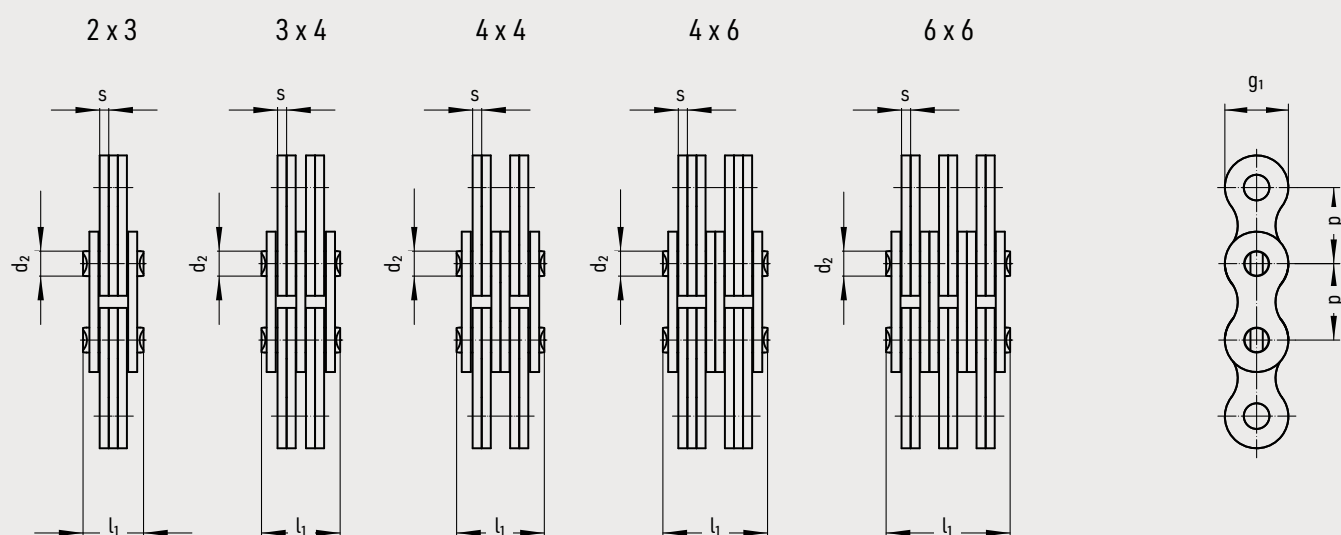

WITRA®	ISO	Nennteilung	Laschen- kombination	Laschenhöhe	Laschendicke	Bolzen- Ø	Breite über Bolzen	Bruchkraft	Gewicht
No.	No.	mm	Lacing	Plate height	Plate thickness	Pin- Ø	Width over pin	Breaking load	Weight
		p		g <sub>1</sub> max.	s max.	d <sub>2</sub> max.	l <sub>1</sub> max.	F <sub>B</sub> min.	q ≈
No.	No.	mm		mm	mm	mm	mm	N	kg/m
WT BL0523	LH1023	15,875	2 x 3	15,1	2,48	5,96	15,40	33 400	1,16
WT BL0534	LH1034	15,875	3 x 4	15,1	2,48	5,96	20,40	48 900	1,62
WT BL0544	LH1044	15,875	4 x 4	15,1	2,48	5,96	22,80	66 700	1,84
WT BL0546	LH1046	15,875	4 x 6	15,1	2,48	5,96	27,70	66 700	2,30
WT BL0566	LH1066	15,875	6 x 6	15,1	2,48	5,96	32,70	100 100	2,74
WT BL0588	LH1088	15,875	8 x 8	15,1	2,48	5,96	42,60	133 400	3,50
WT BL0623	LH1223	19,050	2 x 3	18,1	3,36	7,94	20,80	48 900	1,80
WT BL0634	LH1234	19,050	3 x 4	18,1	3,36	7,94	27,50	75 600	2,49
WT BL0644	LH1244	19,050	4 x 4	18,1	3,36	7,94	30,80	97 900	2,83
WT BL0646	LH1246	19,050	4 x 6	18,1	3,36	7,94	37,50	97 900	3,52
WT BL0666	LH1266	19,050	6 x 6	18,1	3,36	7,94	44,20	146 800	4,21
WT BL0688	LH1288	19,050	8 x 8	18,1	3,36	7,94	57,60	195 700	5,60



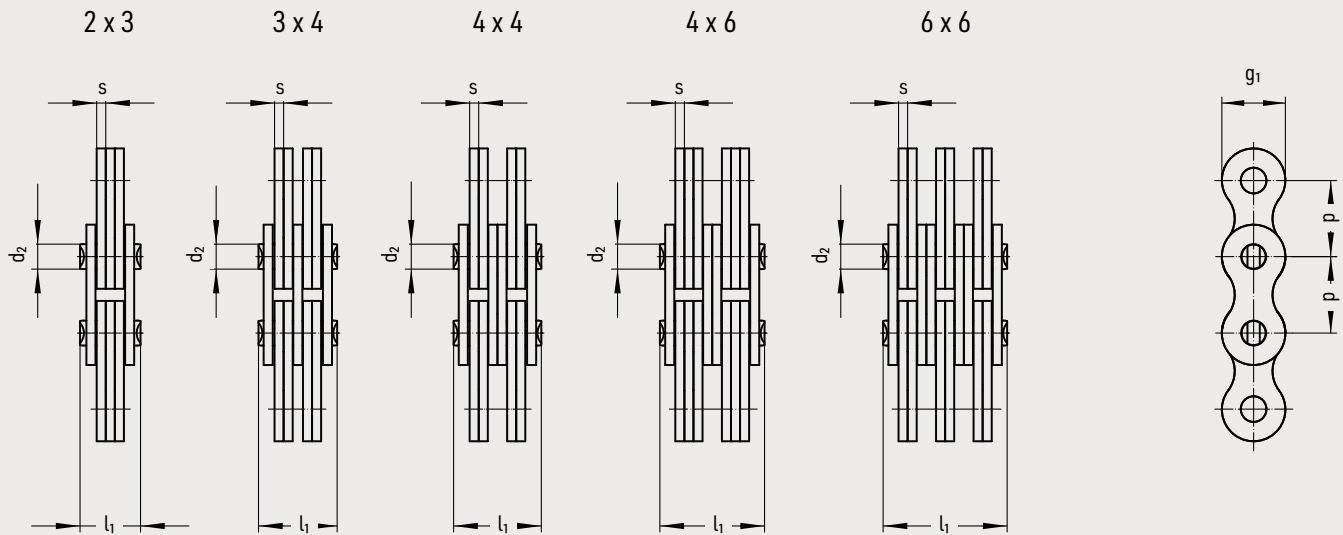

WITRA®	ISO	Nennteilung	Laschen- kombination	Laschenhöhe	Laschendicke	Bolzen- Ø	Breite über Bolzen	Bruchkraft	Gewicht
No.	No.	mm	Lacing	Plate height	Plate thickness	Pin- Ø	Width over pin	Breaking load	Weight
		p		g <sub>1</sub> max.	s max.	d <sub>2</sub> max.	l <sub>1</sub> max.	F <sub>B</sub> min.	q ≈
		mm		mm	mm	mm	mm	N	kg/m
WT BL0823	LH 1623	25,400	2 x 3	24,1	4,09	9,54	25,50	84 500	3,47
WT BL0834	LH 1634	25,400	3 x 4	24,1	4,09	9,54	33,80	129 000	4,82
WT BL0844	LH 1644	25,400	4 x 4	24,1	4,09	9,54	37,90	169 000	5,43
WT BL0846	LH 1646	25,400	4 x 6	24,1	4,09	9,54	46,20	169 000	6,83
WT BL0866	LH 1666	25,400	6 x 6	24,1	4,09	9,54	54,50	253 600	8,19
WT BL0888	LH 1688	25,400	8 x 8	24,1	4,09	9,54	71,00	338 100	8,60
WT BL1023	LH 2023	31,750	2 x 3	30,2	4,90	11,11	30,40	115 600	4,65
WT BL1034	LH 2034	31,750	3 x 4	30,2	4,90	11,11	40,30	182 400	6,46
WT BL1044	LH 2044	31,750	4 x 4	30,2	4,90	11,11	45,20	231 300	7,37
WT BL1046	LH 2046	31,750	4 x 6	30,2	4,90	11,11	55,10	231 300	9,18
WT BL1066	LH 2066	31,750	6 x 6	30,2	4,90	11,11	65,00	347 000	11,00
WT BL1088	LH 2088	31,750	8 x 8	30,2	4,90	11,11	84,80	462 600	13,80
WT BL1234	LH 2434	38,100	3 x 4	36,2	5,77	12,71	47,10	244 600	8,10
WT BL1244	LH 2444	38,100	4 x 4	36,2	5,77	12,71	52,90	302 500	9,30
WT BL1246	LH 2446	38,100	4 x 6	36,2	5,77	12,71	64,60	302 500	11,60
WT BL1266	LH 2466	38,100	6 x 6	36,2	5,77	12,71	76,20	453 700	13,90
WT BL1288	LH 2488	38,100	8 x 8	36,2	5,77	12,71	99,40	605 000	18,60
WT BL1634	LH 3234	50,800	3 x 4	48,2	7,52	17,46	61,80	440 400	14,00
WT BL1644	LH 3244	50,800	4 x 4	48,2	7,52	17,46	69,30	578 300	16,00
WT BL1646	LH 3246	50,800	4 x 6	48,2	7,52	17,46	84,50	578 300	20,00
WT BL1666	LH 3266	50,800	6 x 6	48,2	7,52	17,46	100,00	867 400	24,00
WT BL1688	LH 3288	50,800	8 x 8	48,2	7,52	17,46	129,90	1 156 500	32,00

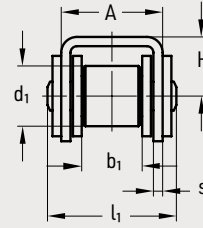
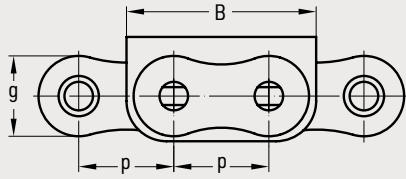

Profil 1  
Profile 1

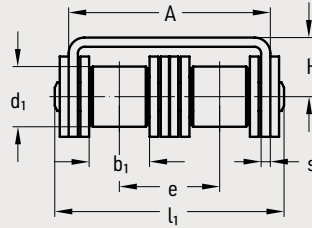
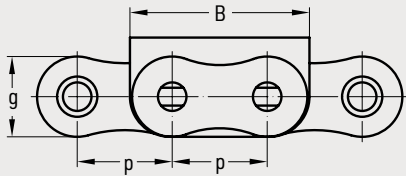

Profil 2  
Profile 2

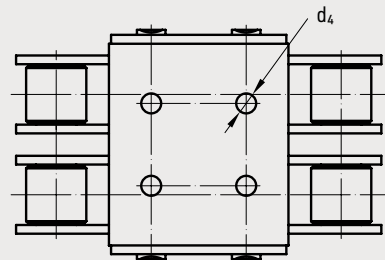
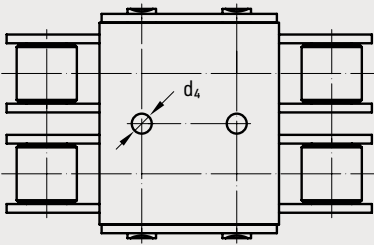

Profil 3  
Profile 3

WITRA®	Teilung		Innere Breite	Innengliedbreite	Rollen-Ø	Laschenhöhe	Maß über Bolzen	Quer- teilung	Mitnehmer-Maße					Profil	Gewicht	Verbindungs- glieder			
	Pitch		Inner width	Inner link width	Roller-Ø	Plate height	Width over pin	Trans- verse pitch	Attachment dimensions								Profile	Weight	Connecting links
	p		b <sub>1</sub> min.	b <sub>2</sub> max.	d <sub>1</sub> max.	g max.	l <sub>1</sub> max.	e	A	B	H	d <sub>4</sub>	s						
No.	mm	inch	mm	mm	mm	mm	mm	mm	mm	mm	mm	mm	mm	mm	mm	mm	kg/m	Type	
08B-1 U1	12,700	1/2	7,75	11,30	8,51	11,80	20,00	-	14,60	24,20	8,30	4,00	1,60	1	1,13	A, E			
08B-2 U1	12,700	1/2	7,75	11,30	8,51	11,80	34,30	13,92	28,40	24,20	8,30	4,00	1,60	3	1,96	A, E			
12B-1 U1	19,050	3/4	11,68	15,62	12,07	16,10	25,70	-	19,60	36,00	13,00	5,00	1,85	1	1,90	A, E			
12B-2 U1	19,050	3/4	11,68	15,62	12,07	16,10	45,30	19,46	39,10	36,00	13,00	5,00	1,85	3	3,03	A, E			
16B-1 U1	25,400	1	17,02	25,40	15,88	21,00	39,70	-	29,05	49,00	15,40	6,00	1,60	1	3,73	A, E, S			
16B-2 U1	25,400	1	17,02	25,40	15,88	21,00	71,70	31,88	60,93	49,00	16,20	6,00	1,60	2	6,15	A, E, S			

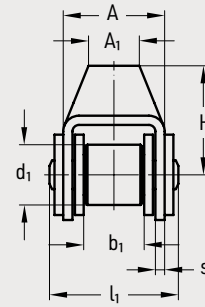
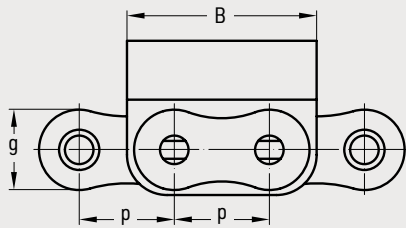

Profil 1  
Profile 1

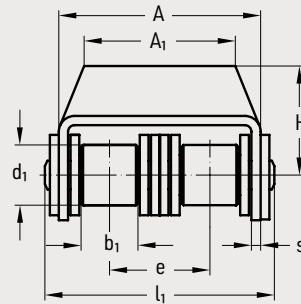
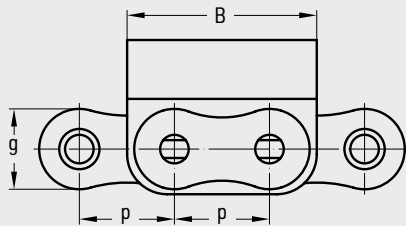

Profil 2  
Profile 2

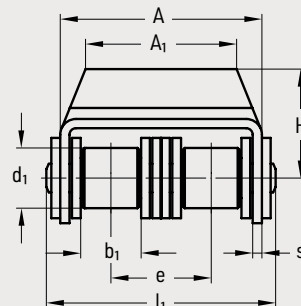
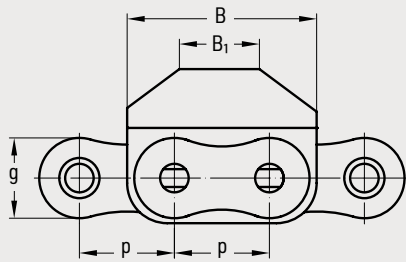
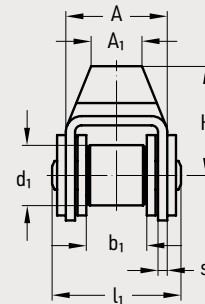
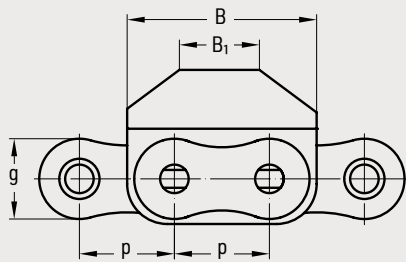

WITRA® No.	Teilung Pitch		Innere Breite Inner width	Innen- glied- breite Inner link width	Rollen- Ø Roller- Ø	Laschen- höhe Plate height	Maß über Bolzen Width over pin	Quer- teilung Trans- verse pitch	Mitnehmer-Maße Attachment dimensions						Profil Profile	Gewicht Weight	Verbindungs- glieder Connecting links
	p								b <sub>1</sub> min.	b <sub>2</sub> max.	d <sub>1</sub> max.	g max.	l <sub>1</sub> max.	e			
	mm	inch	mm	mm	mm	mm	mm	mm	mm	mm	mm	mm	mm	mm	mm	kg/m	Type
08B-1 G1	12,700	1/2	7,75	11,30	8,51	11,80	20,00	-	14,60	-	24,20	-	12,30	1,50	1	1,19	A, E
08B-2 G1	12,700	1/2	7,75	11,30	8,51	11,80	34,30	13,92	28,40	-	24,20	-	12,30	1,50	1	2,07	A, E
08B-2 G2	12,700	1/2	7,75	11,30	8,51	11,80	34,30	13,92	28,40	25,40	24,20	9,00	12,00	1,50	2	2,00	A, E
12B-1 G1	19,050	3/4	11,68	15,62	12,07	16,10	25,70	-	19,60	-	36,00	-	21,00	1,85	1	2,01	A, E
12B-1 G2	19,050	3/4	11,68	15,62	12,07	16,10	45,30	-	19,60	18,60	36,00	26,00	21,00	1,85	2	2,01	A, E
12B-2 G1	19,050	3/4	11,68	15,62	12,07	16,10	45,30	19,46	39,10	-	36,00	-	16,00	1,85	1	3,21	A, E
16B-1 G1	25,400	1	17,02	25,40	15,88	21,00	39,70	-	29,05	29,05	49,00	25,00	21,40	1,60	2	3,83	A, E, S
16B-1 G2	25,400	1	17,02	25,40	15,88	21,00	39,70	-	29,05	29,05	49,00	41,00	21,40	1,60	1	3,83	A, E, S

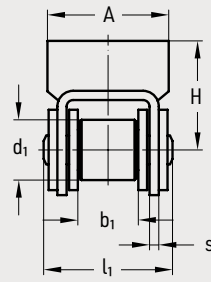
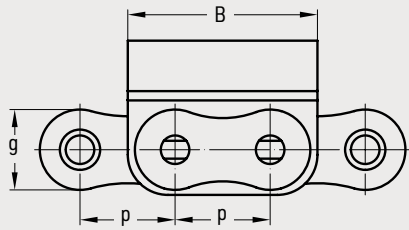

Profil 1  
Profile 1

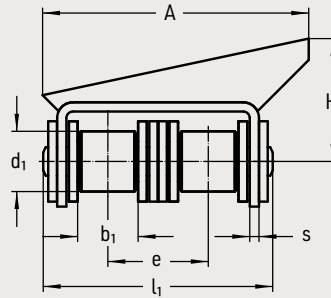
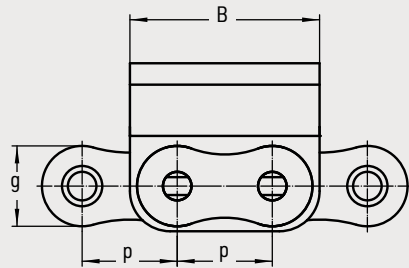

Profil 2  
Profile 2

WITRA®	Teilung		Innere Breite	Innengliedbreite	Rollen-Ø	Laschenhöhe	Maß über Bolzen	Quer- teilung	Mitnehmer-Maße					Profil	Gewicht	Verbindungs- glieder			
	Pitch		Inner width	Inner link width	Roller-Ø	Plate height	Width over pin	Transverse pitch	Attachment dimensions								Profile	Weight	Connecting links
	p		b <sub>1</sub> min.	b <sub>2</sub> max.	d <sub>1</sub> max.	g max.	l <sub>1</sub> max.		e	A	A <sub>1</sub>	B	H						
No.	mm	inch	mm	mm	mm	mm	mm	mm	mm	mm	mm	mm	mm	kg/m	Type				
<b>08B-1 G2</b>	12,700	1/2	7,75	11,30	8,51	11,80	20,00	-	18,00	-	24,20	12,30	1,50	3	1,21	A, E			
<b>08B-2 G3</b>	12,700	1/2	7,75	11,30	8,51	11,80	34,30	13,92	37,90	-	24,20	18,30	1,50	4	2,29	A, E			

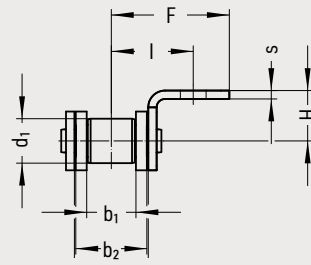
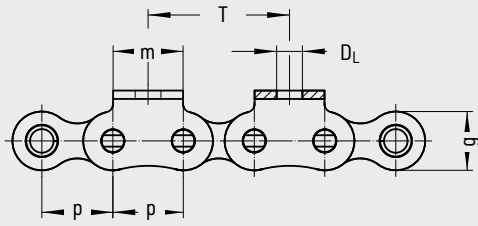

**A**  
einseitige  
Winkellaschen  
bent attachments,  
one side

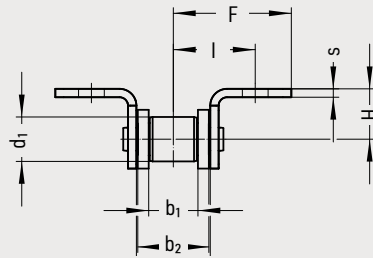
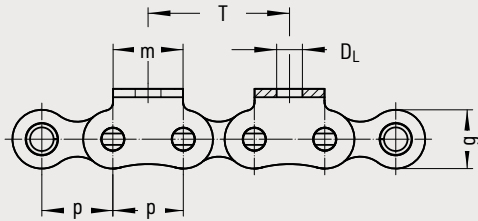

**B**  
zweiseitige  
Winkellaschen  
bent attachments,  
both side

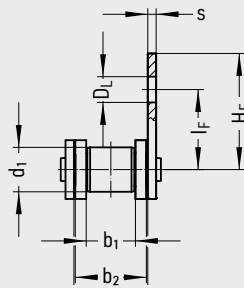
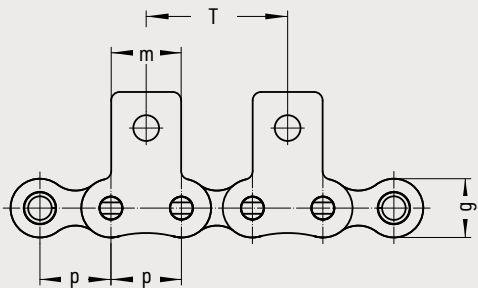

**D**  
einseitige  
Flachlaschen  
straight attachments,  
one side

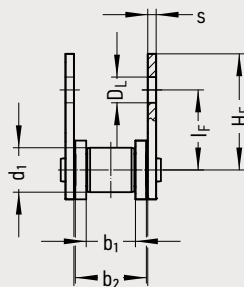
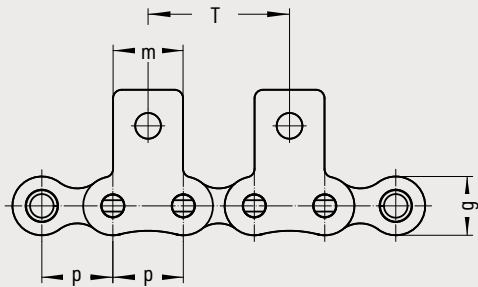

**E**  
zweiseitige  
Flachlaschen  
straight attachments,  
both sides

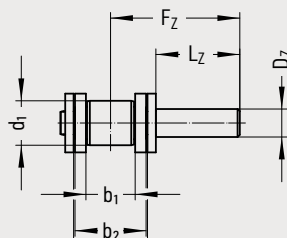
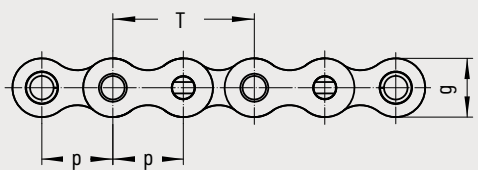

**F**  
einseitige Mitnehmer-  
bolzen (auch versetzt  
wechselseitig möglich)  
extended pins,  
available on  
alternate sides

WITRA®		Similar ISO	Teilung		Innere Breite	Innen-glied-breite	Rollen-Ø	Laschen-höhe	Mitnehmer-Maße											
No.	Ind.	No.	Pitch		Inner width	Inner link width	Roller-Ø	Plate height	Attachment dimensions											
			p		b <sub>1</sub> min.	b <sub>2</sub> max.	d <sub>1</sub> max.	g max.	m	D <sub>L</sub>	l	F	H	l <sub>F</sub>	H <sub>F</sub>	s	D <sub>Z</sub> h9	L <sub>Z</sub>	F <sub>Z</sub>	
			mm	inch	mm	mm	mm	mm	mm	mm	mm	mm	mm	mm	mm	mm	mm	mm	mm	mm
WT 05 SS		05 B-1	8,000	-	3,00	4,77	5,00	7,1	8,0	3,20	6,6	12,0	5,0	7,5	13,0	0,80	4,0	10	13,3	
WT 06 SS	<sup>1</sup>	06 B-1	9,525	3/8	5,72	8,53	6,35	8,2	8,0	3,50	9,5	13,5	6,5	9,0	13,4	1,25	5,0	15	20,7	
WT 08 SS		08 B-1	12,700	1/2	7,75	11,30	8,51	11,8	12,5	4,50	13,1	19,0	10,0	14,7	20,3	1,60	6,0	15	22,4	
WT 10 SS		10 B-1	15,875	5/8	9,65	13,28	10,16	14,7	15,0	5,50	16,7	27,0	10,0	17,2	26,7	1,70	6,5	20	28,5	
WT 12 SS		12 B-1	19,050	3/4	11,68	15,62	12,07	16,1	18,5	6,60	18,5	29,0	11,0	18,7	29,0	1,80	7,0	20	29,8	
WT 16 SS		16 B-1	25,400	1	17,02	25,45	15,88	21,0	25,0	10,00	28,9	41,5	18,0	41,8	28,6	3,00	10,0	30	45,9	

<sup>1</sup> nur mit geraden Laschen / <sup>1</sup> with straight side plates only

Keine Lagerware, nur auf Anfrage. / Not on stock, only on request.



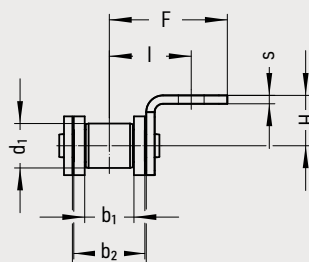
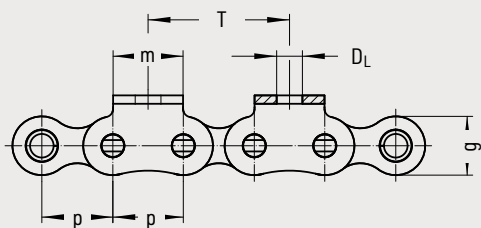

**A**  
einseitige  
Winkellaschen  
bent attachments,  
one side

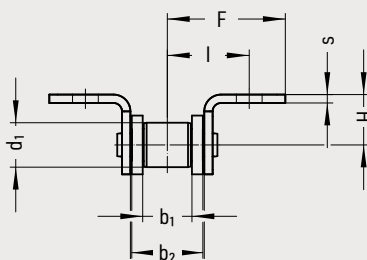
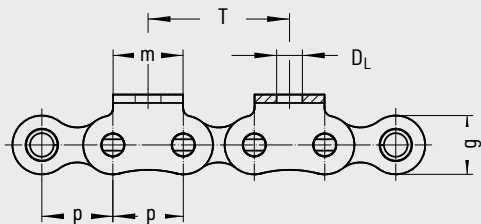

**B**  
zweiseitige  
Winkellaschen  
bent attachments,  
both side

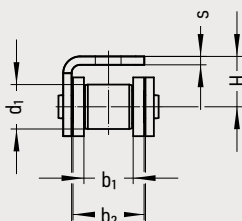
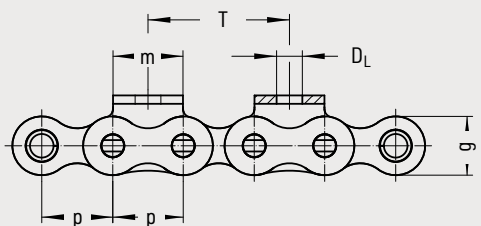

**C**  
Winkellaschen  
einseitig übergreifend  
bent over chain  
attachments, one side

WITRA®		Similar ISO	Nennteilung		Innere Breite	Innengliedbreite	Rollen-Ø	Laschenhöhe	Bruchkraft	Mitnehmer-Maße					
			Pitch		Inner width	Inner link width	Roller-Ø	Plate height	Breaking load DIN	Attachment dimensions					
			p		b <sub>1</sub> min.	b <sub>2</sub> max.	d <sub>1</sub> max.	g max.	F <sub>B</sub> min.	m	D <sub>L</sub>	l	F	H	s
No.	Ind.	No.	mm	inch	mm	mm	mm	mm	N	mm	mm	mm	mm	mm	mm
WT05		05 B-1	8,000		3,00	4,77	5,00	7,1	4 400	8,0	3,20	6,6	12,0	5,0	0,80
WT06	<sup>1</sup>	06 B-1	9,525	3/8	5,72	8,53	6,35	8,2	8 900	8,0	3,50	9,5	13,5	6,5	1,25
WT08		08 B-1	12,700	1/2	7,75	11,30	8,51	11,8	17 800	12,5	4,50	13,1	19,0	10,0	1,50
WT10		10 B-1	15,875	5/8	9,65	13,28	10,16	14,7	22 200	15,0	5,50	16,7	27,0	10,0	1,70
WT12		12 B-1	19,050	3/4	11,68	15,62	12,07	16,1	28 900	18,5	6,60	18,6	29,0	11,0	1,80
WT16		16 B-1	25,400	1	17,02	25,45	15,88	21,0	60 000	25,0	9,00	28,9	41,8	18,0	3,00
WT20		20 B-1	31,750	1 1/4	19,56	29,00	19,05	26,4	95 000	35,0	9,00	33,4	50,0	18,0	3,75
WT24		24 B-1	38,100	1 1/2	25,40	37,90	25,40	33,4	160 000	38,0	11,00	44,0	64,0	25,0	5,00

<sup>1</sup> nur mit geraden Laschen / <sup>1</sup> with straight side plates only

Keine Lagerware, nur auf Anfrage. / Not on stock, only on request.

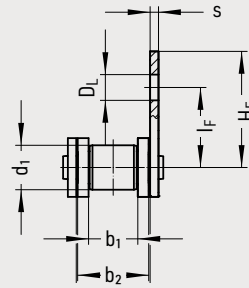
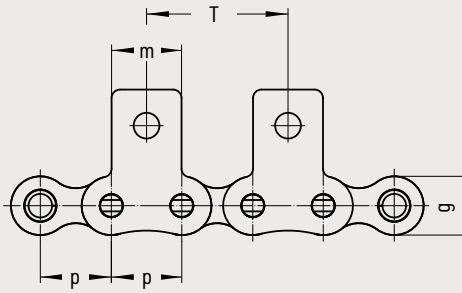

**D**  
einseitige  
Flachlaschen  
straight attachments,  
one side

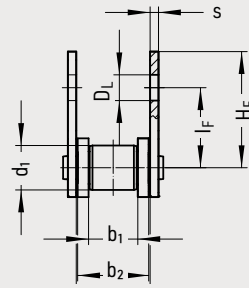
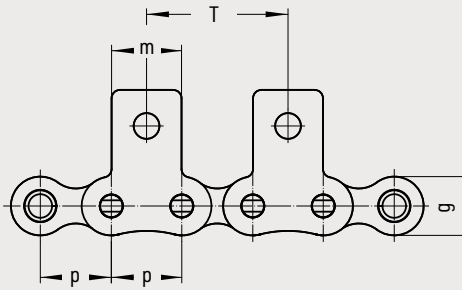

**E**  
zweiseitige  
Flachlaschen  
straight attachments,  
both sides

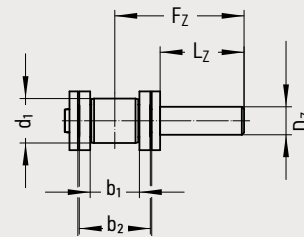
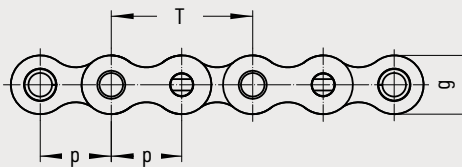

**F**  
einseitige Mitnehmer-  
bolzen (auch versetzt  
wechselseitig möglich)  
extended pins, available  
on alternate sides

WITRA®		Similar ISO	Nennteilung		Innere Breite	Innengliedbreite	Rollen-Ø	Laschenhöhe	Bruchkraft	Mitnehmer-Maße							
No.	Ind.	No.	Pitch		Inner width	Inner link width	Roller-Ø	Plate height	Breaking load DIN	Attachment dimensions							
			p		b <sub>1</sub> min.	b <sub>2</sub> max.	d <sub>1</sub> max.	g max.	F <sub>B</sub> min.	m	D <sub>L</sub>	l <sub>F</sub>	H <sub>F</sub>	s	D <sub>Z</sub> h9	L <sub>Z</sub>	F <sub>Z</sub>
			mm	inch	mm	mm	mm	mm	N	mm	mm	mm	mm	mm	mm	mm	mm
WT 05		05 B-1	8,000	-	3,00	4,77	5,00	7,1	4 400	8,0	3,00	7,5	13,0	0,80	4,0	10	13,3
WT 06	<sup>1</sup>	06 B-1	9,525	3/8	5,72	8,53	6,35	8,2	8 900	8,0	3,50	9,0	13,8	1,25	5,0	15	20,7
WT 08		08 B-1	12,700	1/2	7,75	11,30	8,51	11,8	17 800	12,5	4,50	14,7	20,3	1,50	6,0	15	22,4
WT 10		10 B-1	15,875	5/8	9,65	13,28	10,16	14,7	22 200	15,0	5,50	17,2	26,7	1,70	6,5	20	28,5
WT 12		12 B-1	19,050	3/4	11,68	15,62	12,07	16,1	28 900	18,5	6,60	18,7	29,0	1,80	7,0	20	29,8
WT 16		16 B-1	25,400	1	17,02	25,45	15,88	21,0	60 000	25,0	9,00	28,6	41,5	3,00	10,0	30	45,9
WT 20		20 B-1	31,750	1 1/4	19,56	29,00	19,05	26,4	95 000	35,0	9,00	30,5	45,7	3,75	12,0	30	48,4
WT 24		24 B-1	38,100	1 1/2	25,40	37,90	25,40	33,4	160 000	38,0	11,00	41,0	60,0	5,00	16,0	35	59,1

<sup>1</sup> nur mit geraden Laschen / <sup>1</sup> with straight side plates only

Keine Lagerware, nur auf Anfrage. / Not on stock, only on request.

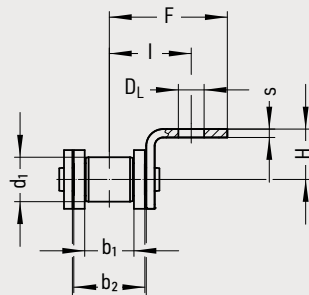
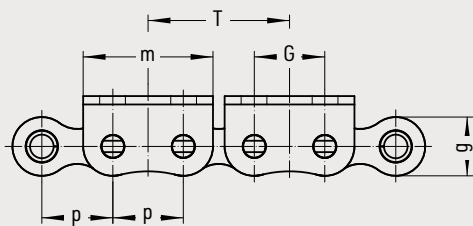

**A2**  
einseitige  
Winkellaschen  
bent attachments,  
one side

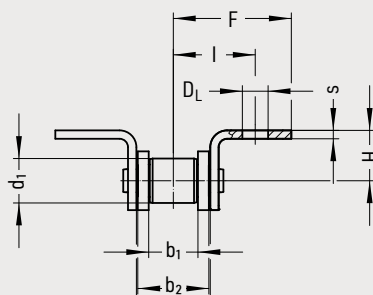
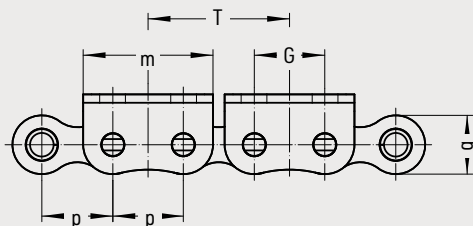

**B2**  
zweiseitige  
Winkellaschen  
bent attachments,  
both side

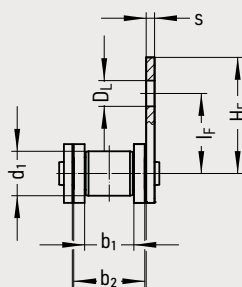
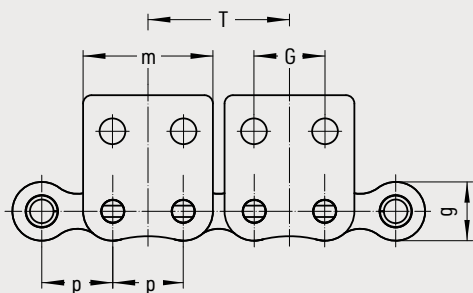

**D2**  
einseitige  
Flachlaschen  
straight attachments,  
one side

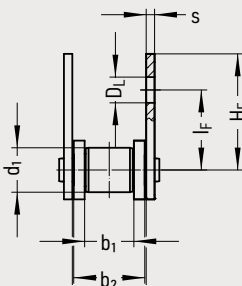
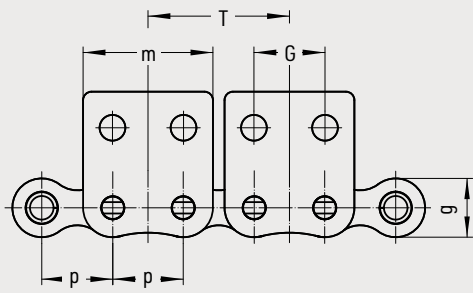

**E2**  
zweiseitige  
Flachlaschen  
straight attachments,  
both sides

WITRA®		Similar ISO	Nennteilung		Innere Breite	Innengliedbreite	Rollen-Ø	Laschenhöhe	Bruchkraft DIN	Mitnehmer-Maße								
No.	Ind.	No.	Pitch		Inner width	Inner link width	Roller-Ø	Plate height	Breaking load DIN	Attachment dimensions								
			p		b <sub>1</sub> min.	b <sub>2</sub> max.	d <sub>1</sub> max.	g max.	F <sub>B</sub> min.	m	DL	G	I	F	H	I <sub>F</sub>	H <sub>F</sub>	s
			mm	inch	mm	mm	mm	mm	N	mm	mm	mm	mm	mm	mm	mm	mm	mm
WT 06	1	06 B-1	9,525	3/8	5,72	8,53	6,35	8,2	8 900	18,2	3,20	9,525	9,8	13,5	5,7	9,2	12,6	1,25
WT 08		08 B-1	12,700	1/2	7,75	11,30	8,51	11,8	17 800	24,4	4,50	12,700	13,1	19,0	10,0	14,7	20,3	1,50
WT 10		10 B-1	15,875	5/8	9,65	13,28	10,16	14,7	22 200	30,3	5,50	15,900	16,7	26,5	10,0	17,2	26,7	1,70
WT 12		12 B-1	19,050	3/4	11,68	15,62	12,07	16,1	28 900	34,8	6,60	19,100	18,6	29,0	11,0	18,7	28,6	1,80
WT 16		16 B-1	25,400	1	17,02	25,45	15,88	21,0	60 000	46,5	9,00	25,400	28,9	41,8	18,0	28,6	41,5	3,00
WT 20		20 B-1	31,750	1 1/4	19,56	29,00	19,05	26,4	95 000	55,8	9,00	31,750	33,4	49,4	18,0	30,5	45,7	3,75
WT 24		24 B-1	38,100	1 1/2	25,40	37,90	25,40	33,4	160 000	81,1	11,00	38,100	43,6	62,6	25,0	41,0	60,0	5,00

<sup>1</sup> nur mit geraden Laschen / <sup>1</sup> with straight side plates only

Keine Lagerware, nur auf Anfrage. / Not on stock, only on request.

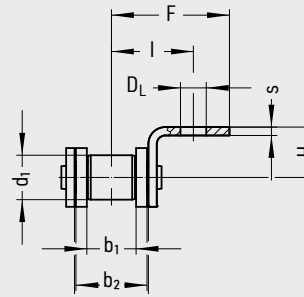
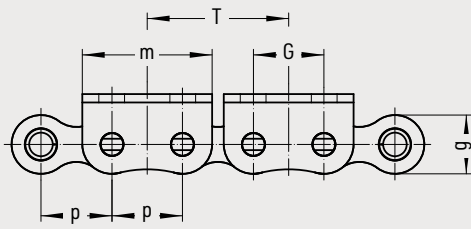

**A2**  
einseitige  
Winkellaschen  
bent attachments,  
one side

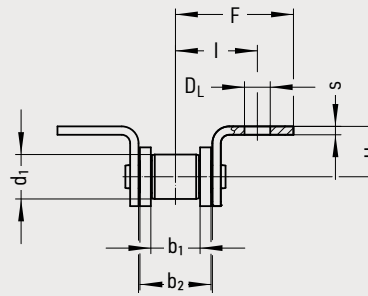
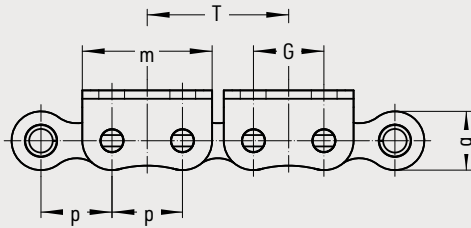

**B2**  
zweiseitige  
Winkellaschen  
bent attachments,  
both side

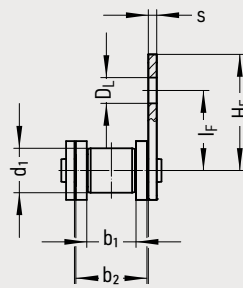
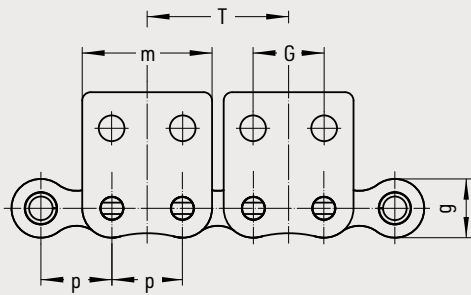

**D2**  
einseitige  
Flachlaschen  
straight attachments,  
one side

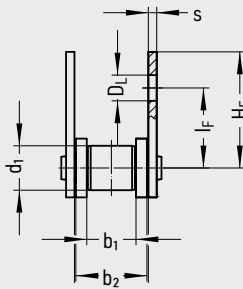
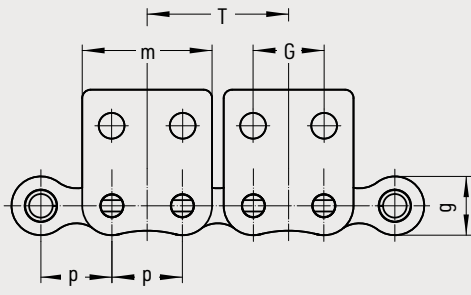

**E2**  
zweiseitige  
Flachlaschen  
straight attachments,  
both sides

WITRA®		Similar ISO	Nennteilung		Innere Breite	Innengliedbreite	Rollen-Ø	Laschenhöhe	Bruchkraft DIN	Mitnehmer-Maße								
No.	Ind.	No.	Pitch		Inner width	Inner link width	Roller-Ø	Plate height	Breaking load DIN	Attachment dimensions								
			p		b <sub>1</sub> min.	b <sub>2</sub> max.	d <sub>1</sub> max.	g max.	F <sub>B</sub> min.	m	D <sub>L</sub>	G	I	F	H	I <sub>F</sub>	H <sub>F</sub>	s
			mm	inch	mm	mm	mm	mm	N	mm	mm	mm	mm	mm	mm	mm	mm	mm
WT 06 SS	1	06B-1	9,525	3/8	5,72	8,53	6,35	8,2	7 000	18,2	3,22	9,525	9,8	13,2	5,7	9,2	12,6	1,25
WT 08 SS		08B-1	12,700	1/2	7,75	11,30	8,51	11,8	12 000	24,4	4,50	12,700	13,1	19,0	10,0	14,7	20,3	1,60
WT 10 SS		10B-1	15,875	5/8	9,65	13,28	10,16	14,7	14 500	30,3	5,50	15,900	16,7	27,0	10,0	17,2	26,7	1,70
WT 12 SS		12B-1	19,050	3/4	11,68	15,62	12,07	16,1	18 500	33,6	6,60	19,100	18,5	29,0	11,0	18,7	29,0	1,80
WT 16 SS		16B-1	25,400	1	17,02	25,45	15,88	21,0	40 000	46,5	10,00	25,400	28,9	41,8	18,0	28,6	41,5	3,00

<sup>1</sup> nur mit geraden Laschen / <sup>1</sup> with straight side plates only

Keine Lagerware, nur auf Anfrage. / Not on stock, only on request.

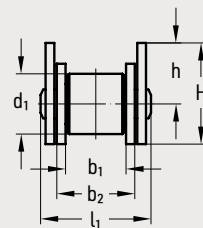
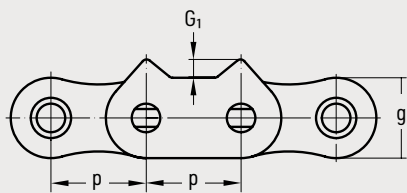

Profil 1  
Profile 1

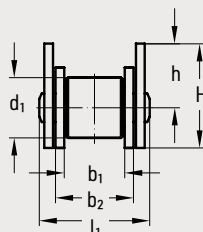
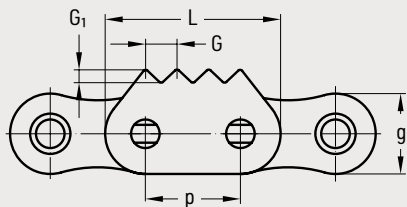

Profil 2  
Profile 2

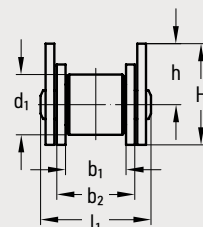
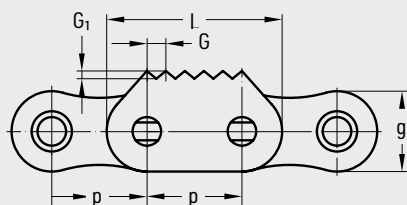

Profil 3  
Profile 3

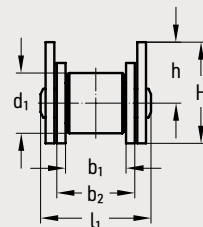
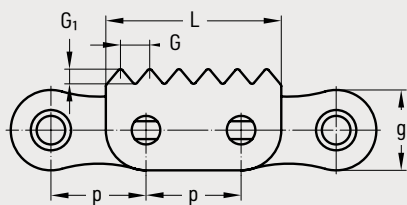

Profil 4  
Profile 4

WITRA®	Teilung		Innere Breite	Innengliedbreite	Rollen-Ø	Laschenhöhe	Maß über Bolzen	Mitnehmer-Maße					Profil	Gewicht	Verbindungs-glieder
	Pitch							Inner width	Inner link width	Roller-Ø	Plate height	Width over pin			
	p		b <sub>1</sub> min.	b <sub>2</sub> max.	d <sub>1</sub> max.	g max.	l <sub>1</sub> max.						G	G <sub>1</sub>	H
No.	mm	inch	mm	mm	mm	mm	mm	mm	mm	mm	mm	mm	mm	kg/m	Type
12B1-F3	19,050	¾	11,68	15,62	12,07	16,10	22,70	6,35	2,72	21,50	13,5	35,05	2*	1,48	A, E
16B1-1170	25,400	1	17,02	25,45	15,88	21,00	36,10	4,23	4,00	26,50	16,00	46,00	2	2,94	A, S
16B1-1185	25,400	1	17,02	25,45	15,88	21,00	36,10	4,00	4,00	26,50	16,00	46,00	4	3,03	A, S
16B1-1185a	25,400	1	17,02	25,45	15,88	21,00	36,10	4,00	4,00	26,50	16,00	46,00	4**	2,87	A, S
16B1-1186	25,400	1	17,02	25,45	15,88	21,00	36,10	4,00	4,00	26,50	16,00	46,00	4*	3,23	A, S
20B1-1350	31,750	1¼	19,56	29,00	19,05	26,40	43,20	-	6,50	33,00	19,80	-	1	4,07	A, S
20B1-1310	31,750	1¼	19,56	29,00	19,05	26,40	43,20	6,35	3,20	33,00	19,80	-	3	4,17	A, S
24B1-4STC	38,100	1½	25,40	37,90	25,40	33,40	53,40	13,00	5,60	35,00	18,30	70,40	2	7,19	A, S

\* Verzahnung an Innen- und Außenlaschen / \* Gearing on inner and outer plates

\*\* Verzahnte Außenlaschen wechselseitig montiert / \*\* Toothed outerplates alternating assembled



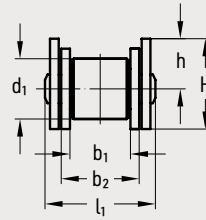
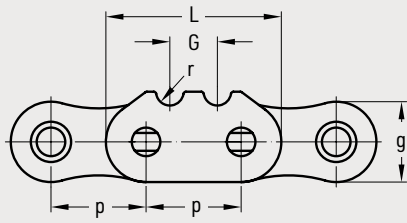

Profil 5  
Profile 5

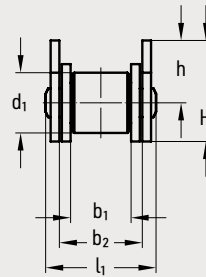
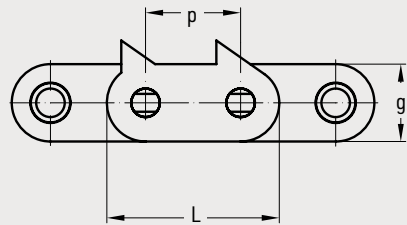

Profil 6  
Profile 6

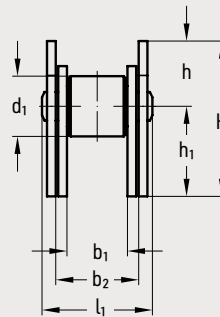
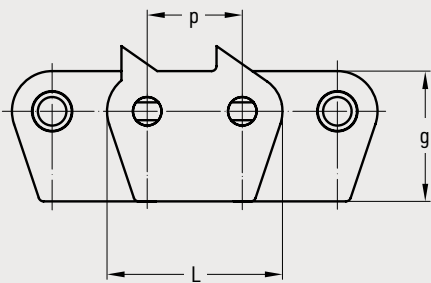

Profil 7  
Profile 7

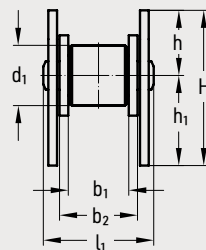
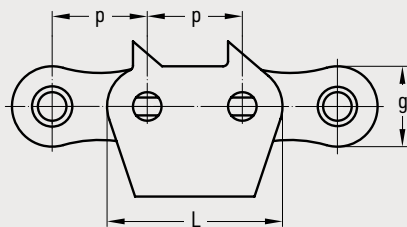

Profil 8  
Profile 8

WITRA® No.	Teilung Pitch		Innere Breite Inner width	Innen- glied- breite Inner link width	Rollen- Ø Roller- Ø	Laschen- höhe Plate height	Maß über Bolzen Width over pin	Mitnehmer-Maße Attachment dimensions						Profil Profile	Gewicht Weight	Verbindungs- glieder Connecting links
	mm	inch	b <sub>1</sub> min.	b <sub>2</sub> max.	d <sub>1</sub> max.	g max.	l <sub>1</sub> max.	L	G	r	H	h	h <sub>1</sub>	q ≈	Type	
	p															
16B1-1180	25,400	1	17,02	25,45	15,88	21,00	36,10	46,00	12,00	3,50	22,50	12,20	-	5	2,84	A, S
16B1-1161	25,400	1	17,02	25,45	15,88	21,00	36,10	46,00	-	-	27,50	16,00	-	6	3,03	A, S
32B1-1872	50,800	2	30,99	45,57	29,21	63,55	67,40	92,80	-	-	73,00	30,00	43,00	7	11,83	A, S
32B1-1874	50,800	2	30,99	45,57	29,21	42,30	67,40	92,80	-	-	73,00	30,00	43,00	8	12,27	A, S

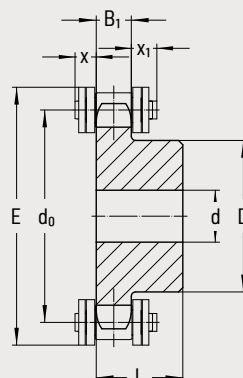
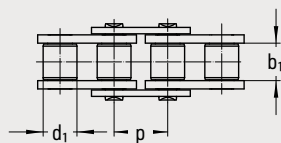

Kette		Teilung		Innere Breite	Rollen-Ø	Maß über Bolzen	Zahnbreite	Überstand	
Chain		Pitch		Inner width	Roller-Ø	Width over pin	Tooth width	Projection	
WITRA®		ISO	p	b <sub>1</sub> min.	d <sub>1</sub> max.	l max.	B <sub>1</sub>	x max.	x <sub>1</sub> max.
No.	Ind.	No.	mm	mm	mm	mm	mm	mm	mm
WT 06		06 B-1	9,525	5,72	6,35	13,50	5,30	4,50	7,80
WT 08		08 B-1	12,700	7,75	8,51	17,00	7,20	5,40	9,30
WT 10		10 B-1	15,875	9,65	10,16	19,60	9,10	5,60	9,70

Zähnezahl	Number of teeth	WT 06 (06 B-1)					WT 08 (08 B-1)					WT 10 (10 B-1)				
		d <sub>0</sub>	E <sub>max</sub>	d	D	L	d <sub>0</sub>	E <sub>max</sub>	d	D	L	d <sub>0</sub>	E <sub>max</sub>	d	D	L
z	Ind.	mm	mm	mm	mm	mm	mm	mm	mm	mm	mm	mm	mm	mm	mm	mm
10		30,82	40,00	8,00	20,00	22,00	41,10	54,00	10,00	26,00	25,00	51,37	68,00	10,00	35,00	25,00
11		33,81	43,00	8,00	22,00	25,00	45,08	58,00	10,00	29,00	25,00	56,35	72,00	12,00	37,00	30,00
12		36,80	46,00	8,00	25,00	25,00	49,07	62,00	10,00	33,00	28,00	61,34	77,00	12,00	42,00	30,00
13		39,80	49,00	10,00	28,00	25,00	53,07	66,00	10,00	37,00	28,00	66,34	82,00	12,00	47,00	30,00
14		42,81	52,00	10,00	31,00	25,00	57,07	70,00	10,00	41,00	28,00	71,34	87,00	12,00	52,00	30,00
15		45,81	55,00	10,00	34,00	25,00	61,08	74,00	10,00	45,00	28,00	76,35	92,00	12,00	57,00	30,00
16		48,82	58,00	10,00	37,00	28,00	65,10	78,00	12,00	50,00	28,00	81,37	97,00	12,00	60,00	30,00
17		51,84	61,00	10,00	40,00	28,00	69,12	82,00	12,00	52,00	28,00	86,39	102,00	12,00	60,00	30,00
18		54,85	64,00	10,00	43,00	28,00	73,14	86,00	12,00	56,00	28,00	91,42	107,00	14,00	70,00	30,00
19		57,87	67,00	10,00	45,00	28,00	77,16	90,00	12,00	60,00	28,00	96,45	112,00	14,00	70,00	30,00
20		60,89	70,00	10,00	46,00	28,00	81,18	94,00	12,00	64,00	28,00	101,48	117,00	14,00	75,00	30,00
21		63,91	73,00	12,00	48,00	28,00	85,21	98,00	12,00	68,00	28,00	106,51	122,00	16,00	75,00	30,00
22		66,93	76,00	12,00	50,00	28,00	89,24	102,00	12,00	70,00	28,00	111,55	127,00	16,00	80,00	30,00
23		69,95	79,00	12,00	52,00	28,00	93,27	106,00	14,00	70,00	28,00	116,59	132,00	16,00	80,00	30,00
24		72,97	82,00	12,00	54,00	28,00	97,30	110,00	14,00	70,00	28,00	121,62	137,00	16,00	80,00	30,00
25		76,00	85,00	12,00	57,00	28,00	101,33	114,00	14,00	70,00	28,00	126,66	142,00	16,00	80,00	30,00
26		79,02	88,00	12,00	60,00	28,00	105,36	118,00	16,00	70,00	30,00	131,70	147,00	20,00	85,00	35,00
27		82,05	92,00	12,00	60,00	28,00	109,40	122,00	16,00	70,00	30,00	136,74	152,00	20,00	85,00	35,00
28		85,07	95,00	12,00	60,00	28,00	113,43	126,00	16,00	70,00	30,00	141,79	157,00	20,00	90,00	35,00
30		91,12	101,00	12,00	60,00	30,00	121,50	134,00	16,00	80,00	30,00	151,87	167,00	20,00	90,00	35,00
32		97,18	107,00	14,00	65,00	30,00	129,57	142,00	16,00	90,00	30,00	161,96	178,00	20,00	95,00	35,00
34		103,23	113,00	14,00	65,00	30,00	137,64	150,00	16,00	90,00	30,00	172,05	188,00	20,00	95,00	35,00
36		109,29	119,00	16,00	70,00	30,00	145,72	158,00	16,00	90,00	35,00	182,14	198,00	20,00	100,00	35,00
38		115,34	125,00	16,00	70,00	30,00	153,79	166,00	16,00	90,00	35,00	192,24	208,00	20,00	100,00	35,00
40		121,40	131,00	16,00	70,00	30,00	161,87	174,00	16,00	90,00	35,00	202,35	218,00	20,00	100,00	35,00
57		172,91	182,00	19,00	78,00	32,00	230,54	243,00	19,00	88,00	40,00	288,18	304,00	23,00	108,00	45,00

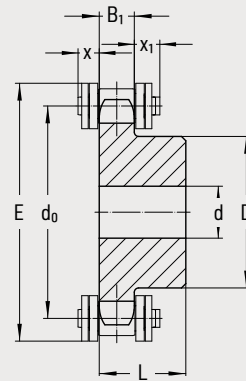
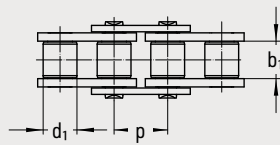

Kette		Teilung	Innere Breite	Rollen-Ø	Maß über Bolzen	Zahnbreite	Überstand		
Chain		Pitch	Inner width	Roller-Ø	Width over pin	Tooth width	Projection		
WITRA®	ISO	p	b <sub>1</sub> min.	d <sub>1</sub> max.	l max.	B <sub>1</sub>	x max.	x <sub>1</sub> max.	
No.	Ind.	No.	mm	mm	mm	mm	mm	mm	
WT 12		12 B-1	19,050	11,68	12,07	22,70	11,10	6,40	11,00
WT 16		16 B-1	25,400	17,02	15,88	36,10	16,20	10,80	16,20
WT 20		20 B-1	31,750	19,56	19,05	43,20	18,50	12,80	18,90

Zähnezahl Number of teeth	z	WT 12 (12 B-1)					WT 16 (16 B-1)					WT 20 (20 B-1)				
		d <sub>0</sub>	E <sub>max</sub>	d	D	L	d <sub>0</sub>	E <sub>max</sub>	d	D	L	d <sub>0</sub>	E <sub>max</sub>	d	D	L
	Ind.	mm	mm	mm	mm	mm	mm	mm	mm	mm	mm	mm	mm	mm	mm	mm
10		61,65	79,00	12,00	42,00	30,00	82,20	104,00	16,00	55,00	35,00	102,75	130,00	20,00	70,00	40,00
11		67,62	85,00	14,00	46,00	35,00	90,16	112,00	16,00	61,00	40,00	112,69	139,00	20,00	77,00	45,00
12		73,60	91,00	14,00	52,00	35,00	98,14	120,00	16,00	69,00	40,00	122,67	149,00	20,00	88,00	45,00
13		79,60	97,00	14,00	58,00	35,00	106,14	128,00	16,00	78,00	40,00	132,67	159,00	20,00	98,00	45,00
14		85,61	103,00	14,00	64,00	35,00	114,15	136,00	16,00	84,00	40,00	142,68	169,00	20,00	108,00	45,00
15		91,62	109,00	14,00	70,00	35,00	122,17	144,00	16,00	92,00	40,00	152,71	179,00	20,00	118,00	45,00
16		97,65	115,00	16,00	75,00	35,00	130,20	152,00	20,00	100,00	45,00	162,74	190,00	25,00	120,00	50,00
17		103,67	121,00	16,00	80,00	35,00	138,23	160,00	20,00	100,00	45,00	172,79	200,00	25,00	120,00	50,00
18		109,71	127,00	16,00	80,00	35,00	146,27	168,00	20,00	100,00	45,00	182,84	210,00	25,00	120,00	50,00
19		115,74	133,00	16,00	80,00	35,00	154,32	176,00	20,00	100,00	45,00	192,90	220,00	25,00	120,00	50,00
20		121,78	139,00	16,00	80,00	35,00	162,37	184,00	20,00	100,00	45,00	202,96	230,00	25,00	120,00	50,00
21		127,82	145,00	20,00	90,00	40,00	170,42	192,00	20,00	110,00	50,00	213,03	240,00	25,00	140,00	55,00
22		133,86	151,00	20,00	90,00	40,00	178,48	200,00	20,00	110,00	50,00	223,10	250,00	25,00	140,00	55,00
23		139,90	157,00	20,00	90,00	40,00	186,54	208,00	20,00	110,00	50,00	233,17	260,00	25,00	140,00	55,00
24		145,95	163,00	20,00	90,00	40,00	194,60	216,00	20,00	110,00	50,00	243,25	270,00	25,00	140,00	55,00
25		151,99	169,00	20,00	90,00	40,00	202,66	224,00	20,00	110,00	50,00	253,32	280,00	25,00	140,00	55,00
26		158,04	176,00	20,00	95,00	40,00	210,72	232,00	20,00	120,00	50,00					
27		164,09	182,00	20,00	95,00	40,00	218,79	240,00	20,00	120,00	50,00					
28		170,14	188,00	20,00	95,00	40,00	226,86	248,00	20,00	120,00	50,00					
30		182,25	200,00	20,00	95,00	40,00	243,00	265,00	20,00	120,00	50,00					
32		194,35	212,00	20,00	100,00	40,00	259,14	281,00	25,00	120,00	50,00					
34		206,46	224,00	20,00	100,00	40,00	275,29	297,00	25,00	120,00	50,00					
36		218,57	236,00	20,00	100,00	40,00	291,43	313,00	25,00	120,00	50,00					
38		230,69	248,00	20,00	100,00	40,00	307,58	329,00	25,00	120,00	50,00					
40		242,80	260,00	20,00	100,00	40,00	323,74	345,00	25,00	120,00	50,00					
57		345,81	363,00	29,00	118,00	56,00										

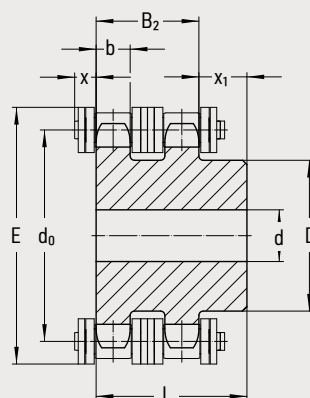
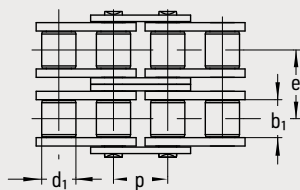

Kette		Teilung	Innere Breite	Rollen-Ø	Maß über Bolzen	Zahnbreite		Überstand		
Chain		Pitch	Inner width	Roller-Ø	Width over pin	Tooth width		Projection		
WITRA®	ISO	p	b <sub>1</sub> min.	d <sub>1</sub> max.	l max.	b	B <sub>2</sub>	x max.	x <sub>1</sub> max.	
No.	Ind.	No.	mm	mm	mm	mm	mm	mm	mm	
WT 06-D		06 B-2	9,525	5,72	6,35	23,80	5,20	15,40	4,50	7,80
WT 08-D		08 B-2	12,700	7,75	8,51	31,00	7,00	21,00	5,40	9,30
WT 10-D		10 B-2	15,875	9,65	10,16	36,20	9,00	25,50	5,60	9,70

Zähnezahl	Number of teeth	WT 06-D (06 B-2)					WT 08-D (08 B-2)					WT 10-D (10 B-2)				
		d <sub>0</sub>	E <sub>max</sub>	d	D	L	d <sub>0</sub>	E <sub>max</sub>	d	D	L	d <sub>0</sub>	E <sub>max</sub>	d	D	L
z	Ind.	mm	mm	mm	mm	mm	mm	mm	mm	mm	mm	mm	mm	mm	mm	mm
10		30,82	40,00	8,00	20,00	22,00	41,10	54,00	10,00	28,00	32,00	51,37	68,00	12,00	35,00	40,00
11		33,81	43,00	10,00	22,00	25,00	45,08	58,00	12,00	32,00	35,00	56,35	72,00	14,00	39,00	40,00
12		36,80	46,00	10,00	25,00	25,00	49,07	62,00	12,00	35,00	35,00	61,34	77,00	14,00	44,00	40,00
13		39,80	49,00	10,00	28,00	25,00	53,07	66,00	12,00	38,00	35,00	66,34	82,00	14,00	49,00	40,00
14		42,81	52,00	10,00	31,00	25,00	57,07	70,00	12,00	42,00	35,00	71,34	87,00	14,00	54,00	40,00
15		45,81	55,00	10,00	34,00	25,00	61,08	74,00	12,00	46,00	35,00	76,35	92,00	14,00	59,00	40,00
16		48,82	58,00	12,00	37,00	30,00	65,10	78,00	14,00	50,00	35,00	81,37	97,00	16,00	64,00	45,00
17		51,84	61,00	12,00	40,00	30,00	69,12	82,00	14,00	54,00	35,00	86,39	102,00	16,00	69,00	45,00
18		54,85	64,00	12,00	43,00	30,00	73,14	86,00	14,00	58,00	35,00	91,42	107,00	16,00	74,00	45,00
19		57,87	67,00	12,00	46,00	30,00	77,16	90,00	14,00	62,00	35,00	96,45	112,00	16,00	79,00	45,00
20		60,89	70,00	12,00	49,00	30,00	81,18	94,00	14,00	66,00	35,00	101,48	117,00	16,00	84,00	45,00
21		63,91	73,00	12,00	52,00	30,00	85,21	98,00	16,00	70,00	40,00	106,51	122,00	16,00	85,00	45,00
22		66,93	76,00	12,00	55,00	30,00	89,24	102,00	16,00	70,00	40,00	111,55	127,00	16,00	90,00	45,00
23		69,95	79,00	12,00	58,00	30,00	93,27	106,00	16,00	70,00	40,00	116,59	132,00	16,00	95,00	45,00
24		72,97	82,00	12,00	61,00	30,00	97,30	110,00	16,00	75,00	40,00	121,62	137,00	16,00	100,00	45,00
25		76,00	85,00	12,00	64,00	30,00	101,33	114,00	16,00	80,00	40,00	126,66	142,00	16,00	105,00	45,00

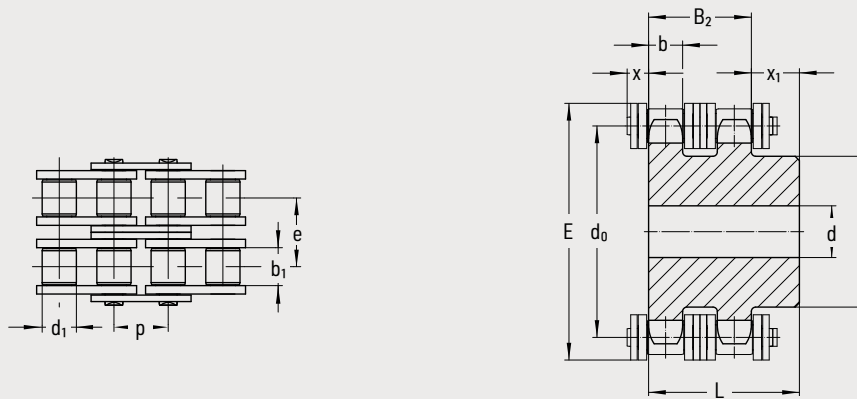

Kette		Teilung	Innere Breite	Rollen-Ø	Maß über Bolzen	Zahnbreite		Überstand		
Chain		Pitch	Inner width	Roller-Ø	Width over pin	Tooth width		Projection		
WITRA®	ISO	p	b <sub>1</sub> min.	d <sub>1</sub> max.	l max.	b	B <sub>2</sub>	x max.	x <sub>1</sub> max.	
No.	Ind.	No.	mm	mm	mm	mm	mm	mm	mm	
<b>WT 12-D</b>		<b>12 B-2</b>	19,050	11,68	12,07	42,20	10,80	30,30	6,40	11,00
<b>WT 16-D</b>		<b>16 B-2</b>	25,400	17,02	15,88	68,00	15,80	47,70	10,80	16,20

Zähnezahl Number of teeth z	WT 12-D (12 B-2)					WT 16-D (16 B-2)				
	d <sub>0</sub>	E <sub>max</sub>	d	D	L	d <sub>0</sub>	E <sub>max</sub>	d	D	L
Ind.	mm	mm	mm	mm	mm	mm	mm	mm	mm	mm
10	61,65	79,00	12,00	42,00	45,00	82,20	104,00	16,00	56,00	65,00
11	67,62	85,00	16,00	47,00	50,00	90,16	112,00	20,00	64,00	70,00
12	73,60	91,00	16,00	53,00	50,00	98,14	120,00	20,00	72,00	70,00
13	79,60	97,00	16,00	59,00	50,00	106,14	128,00	20,00	80,00	70,00
14	85,61	103,00	16,00	65,00	50,00	114,15	136,00	20,00	88,00	70,00
15	91,62	109,00	16,00	71,00	50,00	122,17	144,00	20,00	96,00	70,00
16	97,65	115,00	20,00	77,00	50,00	130,20	152,00	20,00	104,00	70,00
17	103,67	121,00	20,00	83,00	50,00	138,23	160,00	20,00	112,00	70,00
18	109,71	127,00	20,00	89,00	50,00	146,27	168,00	20,00	120,00	70,00
19	115,74	133,00	20,00	95,00	50,00	154,32	176,00	20,00	128,00	70,00
20	121,78	139,00	20,00	100,00	50,00	162,37	184,00	20,00	130,00	70,00
21	127,82	145,00	20,00	100,00	50,00	170,42	192,00	25,00	130,00	70,00
22	133,86	151,00	20,00	100,00	50,00	178,48	200,00	25,00	130,00	70,00
23	139,90	157,00	20,00	110,00	50,00	186,54	208,00	25,00	130,00	70,00
24	145,95	163,00	20,00	110,00	50,00	194,60	216,00	25,00	130,00	70,00
25	151,99	169,00	20,00	120,00	50,00	202,66	224,00	25,00	130,00	70,00



Kette		Teilung	Innere Breite	Rollen- Ø	Maß über Bolzen	Zahnbreite	
Chain							
WITRA®	ISO	p	Inner width	Roller- Ø	Width over pin	Tooth width	
No.	Ind.	No.	b <sub>1</sub> min.	d <sub>1</sub> max.	l max.	B <sub>1</sub>	
		mm	mm	mm	mm	mm	
<b>WT 06</b>		<b>06B-1</b>	9,525	5,72	6,35	13,50	5,30
<b>WT 08</b>		<b>08B-1</b>	12,700	7,75	8,51	17,00	7,20
<b>WT 10</b>		<b>10B-1</b>	15,875	9,65	10,16	19,56	9,10

Zähne- zahl	Number of teeth	WT 06 (06 B-1)			WT 08 (08 B-1)			WT 10 (10 B-1)		
		d <sub>0</sub>	E <sub>max</sub>	d	d <sub>0</sub>	E <sub>max</sub>	d	d <sub>0</sub>	E <sub>max</sub>	d
z	Ind.	mm	mm	mm	mm	mm	mm	mm	mm	mm
10		30,82	40,00	8,00	41,10	54,00	10,00	51,37	68,00	10,00
11		33,81	43,00	8,00	45,08	58,00	10,00	56,35	72,00	10,00
12		36,80	46,00	8,00	49,07	62,00	10,00	61,34	77,00	10,00
13		39,80	49,00	8,00	53,07	66,00	10,00	66,34	82,00	10,00
14		42,81	52,00	8,00	57,07	70,00	10,00	71,34	87,00	10,00
15		45,81	55,00	8,00	61,08	74,00	10,00	76,35	92,00	10,00
16		48,82	58,00	10,00	65,10	78,00	10,00	81,37	97,00	12,00
17		51,84	61,00	10,00	69,12	82,00	10,00	86,39	102,00	12,00
18		54,85	64,00	10,00	73,14	86,00	10,00	91,42	107,00	12,00
19		57,87	67,00	10,00	77,16	90,00	10,00	96,45	112,00	12,00
20		60,89	70,00	10,00	81,18	94,00	10,00	101,48	117,00	12,00
21		63,91	73,00	10,00	85,21	98,00	12,00	106,51	122,00	12,00
22		66,93	76,00	10,00	89,24	102,00	12,00	111,55	127,00	12,00
23		69,95	79,00	10,00	93,27	106,00	12,00	116,59	132,00	12,00
24		72,97	82,00	10,00	97,30	110,00	12,00	121,62	137,00	12,00
25		76,00	85,00	10,00	101,33	114,00	12,00	126,66	142,00	12,00
26		79,02	88,00	10,00	105,36	118,00	16,00	131,70	147,00	16,00
27		82,05	92,00	10,00	109,40	122,00	16,00	136,74	152,00	16,00
28		85,07	95,00	10,00	113,43	126,00	16,00	141,79	157,00	16,00
30		91,12	101,00	10,00	121,50	134,00	16,00	151,87	167,00	16,00
32		97,18	107,00	12,00	129,57	142,00	16,00	161,96	178,00	16,00
34		103,23	113,00	12,00	137,64	150,00	16,00	172,05	188,00	16,00
36		109,29	119,00	12,00	145,72	158,00	16,00	182,14	198,00	20,00
38		115,34	125,00	12,00	153,79	166,00	16,00	192,24	208,00	20,00
40		121,40	131,00	12,00	161,87	174,00	16,00	202,35	218,00	20,00
57		172,91	182,00	16,00	230,54	243,00	20,00	288,18	304,00	25,00



Kette		Teilung	Innere Breite	Rollen- Ø	Maß über Bolzen	Zahnbreite	
Chain							
WITRA®	ISO	Pitch	Inner width	Roller- Ø	Width over pin	Tooth width	
	No.	No.	p	$b_1$ min.	$d_1$ max.	l max.	$B_1$
No.	Ind.	No.	mm	mm	mm	mm	mm
WT 12		12 B-1	19,050	11,68	12,07	22,70	11,10
WT 16		16 B-1	25,400	17,02	15,88	36,10	16,20
WT 20		20 B-1	31,750	19,56	19,05	43,20	18,50

Zähne- zahl	Number of teeth	WT 12 (12 B-1)			WT 16 (16 B-1)			WT 20 (20 B-1)		
		$d_0$	$E_{max}$	d	$d_0$	$E_{max}$	d	$d_0$	$E_{max}$	d
z	Ind.	mm	mm	mm	mm	mm	mm	mm	mm	mm
10		61,65	79,00	14,00	82,20	104,00	15,00	102,75	130,00	16,00
11		67,62	85,00	14,00	90,16	112,00	15,00	112,69	139,00	16,00
12		73,60	91,00	14,00	98,14	120,00	15,00	122,67	149,00	20,00
13		79,60	97,00	14,00	106,14	128,00	15,00	132,67	159,00	20,00
14		85,61	103,00	14,00	114,15	136,00	15,00	142,68	169,00	20,00
15		91,62	109,00	14,00	122,17	144,00	15,00	152,71	179,00	20,00
16		97,65	115,00	14,00	130,20	152,00	19,00	162,74	190,00	25,00
17		103,67	121,00	14,00	138,23	160,00	19,00	172,79	200,00	25,00
18		109,71	127,00	14,00	146,27	168,00	19,00	182,84	210,00	25,00
19		115,74	133,00	14,00	154,32	176,00	19,00	192,90	220,00	25,00
20		121,78	139,00	14,00	162,37	184,00	19,00	202,96	230,00	25,00
21		127,82	145,00	16,00	170,42	192,00	20,00	213,03	240,00	25,00
22		133,86	151,00	16,00	178,48	200,00	20,00	223,10	250,00	25,00
23		139,90	157,00	16,00	186,54	208,00	20,00	233,17	260,00	25,00
24		145,95	163,00	16,00	194,60	216,00	20,00	243,25	270,00	25,00
25		151,99	169,00	16,00	202,66	224,00	20,00	253,32	280,00	25,00
26		158,04	176,00	16,00	210,72	232,00	20,00			
27		164,09	182,00	16,00	218,79	240,00	20,00			
28		170,14	188,00	16,00	226,86	248,00	20,00			
30		182,25	200,00	16,00	243,00	265,00	20,00			
32		194,35	212,00	20,00	259,14	281,00	25,00			
34		206,46	224,00	20,00	275,29	297,00	25,00			
36		218,57	236,00	20,00	291,43	313,00	25,00			
38		230,69	248,00	20,00	307,58	329,00	25,00			
40		242,80	260,00	20,00	323,74	345,00	25,00			
57		345,81	363,00	25,00						



## Allgemeines

Ein Kettentrieb benötigt verhältnismäßig wenig Wartung, wenn die Kette richtig ausgewählt worden ist, fehlerfrei eingebaut wurde und die empfohlene Schmierung erhält.

Die Kette sollte jedoch vor Schmutz und ungünstigen Umgebungseinflüssen geschützt werden. Ein Kettenschutzkasten verhindert Verschmutzung, verhindert Unfälle und wirkt stark geräuschkämpfend.

Die Wartung besteht bei geschützten Antrieben in einer regelmäßigen (jährlichen) Reinigung des Ölbehälters und Erneuerung der Ölfüllung. Offen laufende Kettentriebe sind etwa alle 3 bis 6 Monate zu reinigen. Je nach Verschmutzung kann auch ein kürzerer Zeitraum nötig sein. Bei dieser Gelegenheit sollte gleichzeitig die Fluchtung der Räder und die Kettenspannung geprüft werden.

## Reinigung

Zur Erzielung einer gründlichen Reinigung entfernt man zunächst von dem Kettentrieb den äußerlich anhaftenden groben Schmutz mit einer harten oder stählernen Bürste. Dann spült man die Kette in Waschbenzin, Petroleum oder Dieselöl. Eine weitere Reinigung gilt besonders der Beseitigung des Schmutzes an den inneren Teilen der Kette. Hierzu wird die Kette zirka 24 Stunden in Petroleum, Dieselöl oder ein anderes Lösungsmittel gelegt, um den Schmutz in den Gelenken und verhärtete Schmiermittelreste aufzuweichen.

Mehrfaches Hin- und Herbewegen der Kette in diesem Bad spült die Gelenke sauber. Nach sorgfältig durchgeführter Reinigung darf die Kette beim Bewegen der Glieder keine kratzenden Geräusche mehr verursachen; andernfalls würde der in den Gelenken zurückgebliebene Schmutz mit dem Schmiermittel eine Schleifpaste bilden und die Kette schnell zerstören.

## Reparatur

Man untersuche sodann die Kette auf etwa vorhandene schadhafte Glieder und wechsele diese gegebenenfalls aus.

Bei einem beschädigten Außenglied wird einfach anstelle des defekten Gliedes ein Steckglied eingesetzt. In eine endlose Kette wird ein Außenglied eingietet.

Ist ein Innenglied oder eine Rolle gebrochen, müssen auch die beiden benachbarten Glieder entfernt und durch ein Innenglied mit zwei Steckgliedern ersetzt werden. Bei endloser Kette sind Außenglieder zu verwenden.

Eine Kette, die sichtlich verschlissen ist, sollte jedoch nicht mehr repariert, sondern gegen eine neue ausgetauscht werden.

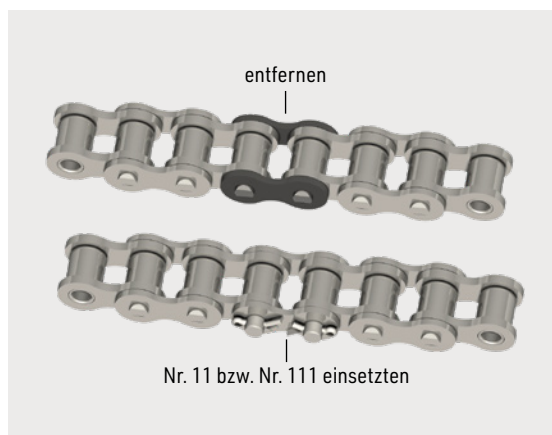

## Wiedereinfettung

Die gründliche Wiedereinfettung muss sofort nach der Reinigung und etwaigen Reparatur der Kette erfolgen. Es ist unbedingt darauf zu achten, dass die Qualität und Viskosität des Schmiermittels den Betriebsbedingungen des Kettentriebes wie Temperatur und Geschwindigkeit entspricht. Das Auftropfen oder nur einfache Übergießen mit der Ölkanne ist weniger empfehlenswert, weil das Öl dabei kaum an die eigentlichen Schmierstellen, die Kettengelenke gelangt. Auch wenn jeweils zwischen die Innen- und Außenlaschen Öl getropft wird, ist dadurch noch nicht gewährleistet, dass die Innenteile, Bolzen und Buchsen wirksam geschmiert sind.

Bei einer idealen Schmierung wird die gut gereinigte Kette in ein auf 120° C erwärmtes Bad mit verflüssigtem Spezialkettenfett gelegt und solange darin belassen, bis sie dessen Temperatur erreicht hat. Dann wird die Kette aus dem Bad genommen. Man lässt sie gut abtropfen, weil das außen an den Laschen anhaftende Fett zur Schmierung der Kettengelenke nicht wirksam ist. Da eine solche ideale Schmierung in den meisten Fällen nicht möglich ist, sollte ein gutes Motoren-Schmieröl verwendet werden. Es ist darauf zu achten, dass das Schmiermittel die zu schmierenden Gelenke erreicht.

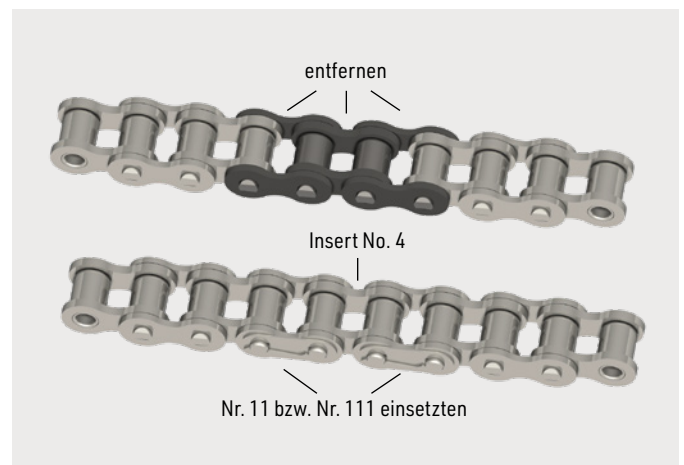

## Kettenräder

Vor dem Wiederauflegen der Kette sind die Zähne der zugehörigen Kettenräder gründlich zu reinigen. Vor allem müssen die Schmutzablagerungen im Grund der Zahnluken entfernt werden, weil dadurch die Kette gedehnt wird. Anschließend ist die Verzahnung daraufhin zu untersuchen, ob die Zähne nicht zu weit abgenutzt sind. Bei starkem Verschleiß oder hakenförmigen Zähnen werden die Räder besser durch neue ersetzt.

Ein abgenutztes Kettenrad nur umzudrehen, also in entgegengesetzter Laufrichtung arbeiten zu lassen, ist nicht zu empfehlen. Die neuen Räder werden nach den Angaben kontrolliert.

Niemals eine neue Kette auf ein abgenutztes Kettenrad legen, weil dadurch die Kette schnell unbrauchbar wird.



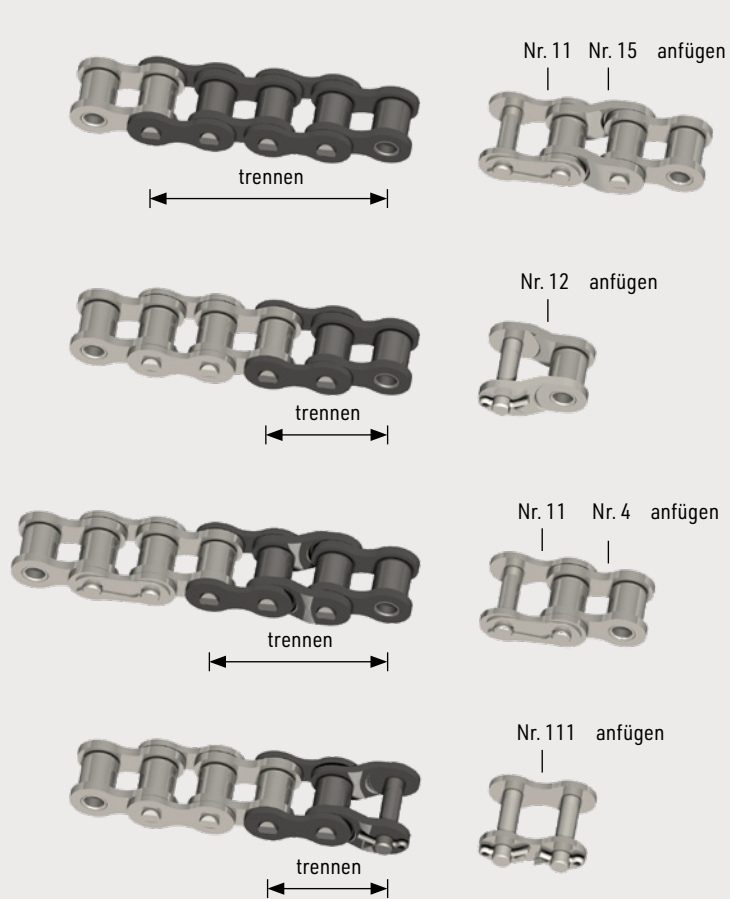

Kürzen um 1 Glied

**A**  
**Gerade Gliederzahl**  
bis Teilung 19,05 mm

ab Teilung 25,4 mm

**B**  
**Ungerade Gliederzahl**  
bis Teilung 19,05 mm

ab Teilung 25,4 mm

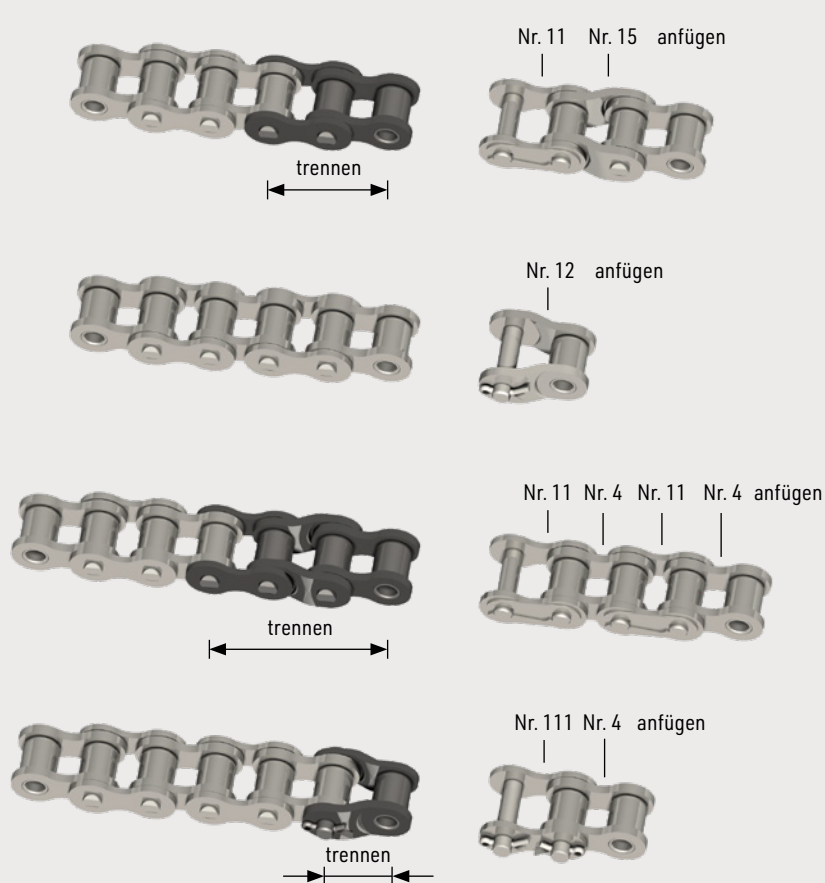

Verlängern um 1 Glied

**A**  
**Gerade Gliederzahl**  
bis Teilung 19,05 mm

ab Teilung 25,4 mm

**B**  
**Ungerade Gliederzahl**  
bis Teilung 19,05 mm

ab Teilung 25,4 mm

Achtung: Bei Einbau von gekröpften Gliedern darf nur mit 80% der Bruchlast gerechnet werden.

## General information

A chain drive needs relatively little maintenance, if the correct chain was selected, if it was installed correctly and if it is lubricated according to the recommended procedure.

However, the chain should be protected against dirt and adverse environmental influences. A chain protection box helps to prevent dirt, averts accidents and absorbs noise.

In case of protected drives maintenance comprises a regular (annual) cleaning of the oil container and a renewal of the oil filling.

Open running chain drives must be cleaned every 3 to 6 months.

Shorter periods may be necessary, if the chains are very dirty. When cleaning the chain drives, wheel alignment and chain tension should be checked as well.

## Cleaning

First of all, in order to clean a chain drive properly, the external rough dirt must be removed by means of a hard or steel brush. Subsequently, the chain is rinsed in cleaning solvent, paraffin or diesel oil. Furthermore, it is important to clean the inner parts of the chain. Therefore the chain is placed into paraffin, diesel oil or another solvent for approximately 24 hours in order to soak the dirt in the joints as well as the hardened lubrication remnants.

If the chain is moved several times back and forth in the solvent bath, joints will be thoroughly cleaned.

After the chain has been properly cleaned it should not make anymore scratching noises when the links are moved; if it does, the remaining dirt in the joints will form a grinding compound with the lubricating agent, which would destroy the chain very quickly.

## Repair

Subsequently the chain should be carefully examined for defective links, which must be replaced, if necessary.

A damaged outer link is replaced with a connecting link. Outer links are riveted into endless chains.

If an inner link or a roller is broken, the two adjoining links must also be removed; they must then be replaced by an inner link with two connecting links.

With endless chains outer links are to be used. However, if a chain looks really worn, it should be replaced by a new one.

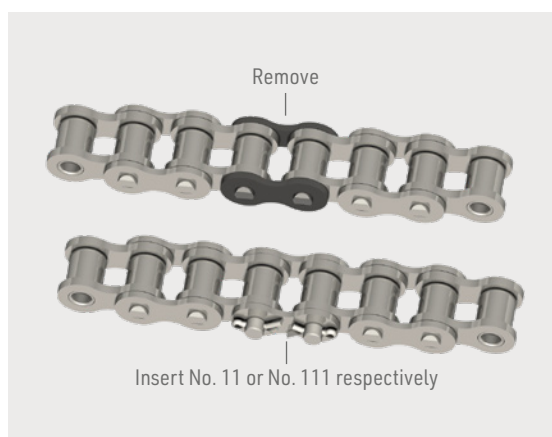

## Relubrication

Thorough relubrication is to be carried out immediately after cleaning and, if necessary, repair of the chain. It is important to ensure that quality and viscosity of the lubricant comply with the operating conditions of the chain drive, e.g. temperature and velocity. It is not recommended to add just a few drops from the oil can or simply douse the chain, since the oil will not reach the chain links, i.e. those parts which actually have to be lubricated. Even if the inner and outer plates are oiled, this will by no means guarantee a proper lubrication of the inner parts such as pins and bushings.

For perfect lubrication the chain is placed into a container with liquidised special chain lubricant heated up to 120° C. The chain is left in the lubricant bath until it has reached its temperature, before it is then taken out. Excess lubricant must be allowed to drip off since it will not aid the lubrication of the chains links if it sticks to the outer plates.

However, in practice, such perfect lubrication will rarely be possible. In this case an excellent engine lubricating oil should be used. Please ensure that the lubricant will actually reach the links, which are to be lubricated.

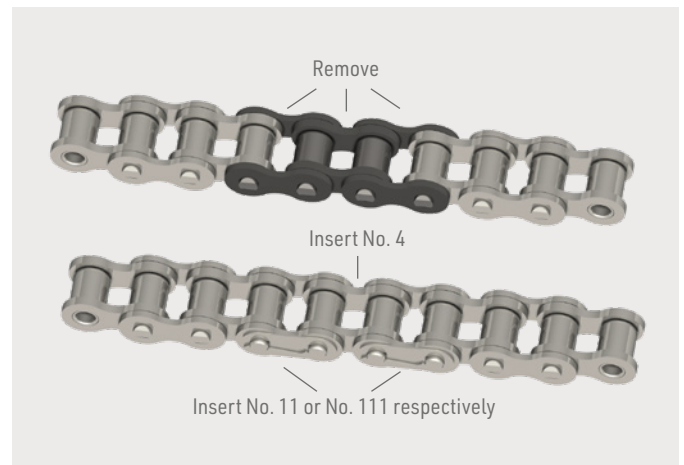

## Sprockets

The sprocket teeth must be thoroughly cleaned before the chain is finally put back on.

It is particularly important to remove dirt sediments, which would stretch the chain, from the bottom of the tooth gaps. Subsequently, the sprocket must be examined in order to determine, if the teeth are worn too much.

In case of excessive wear or hooked-shaped teeth, sprockets should be replaced with new ones.

It is not recommended to simply turn a worn sprocket around so that it works in reverse running direction. New sprockets are to be checked.

Please note that a new chain should never be placed around a worn sprocket, because this will definitely reduce the lifecycle of the chain.



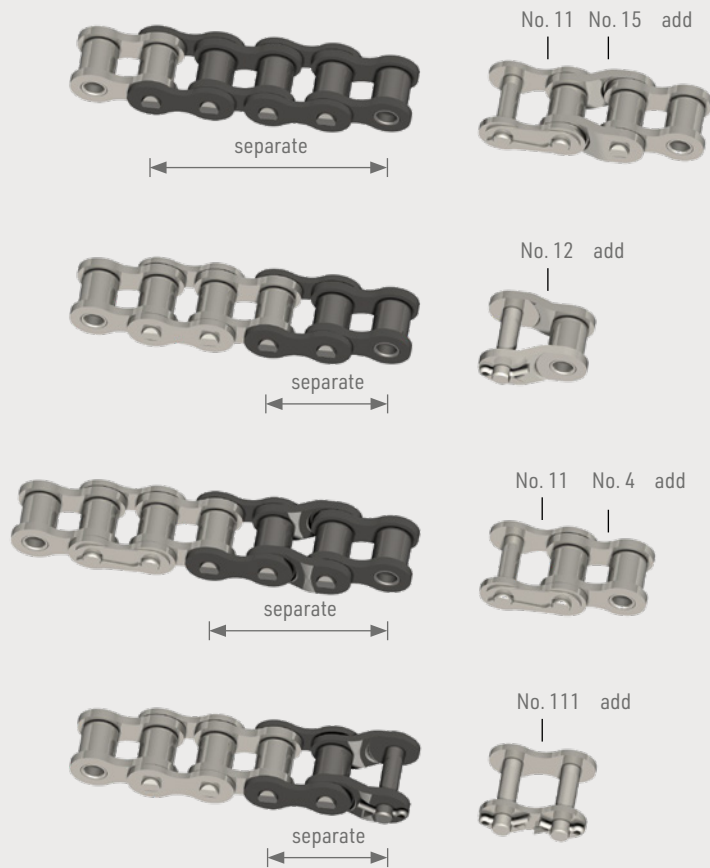

## Shortening by 1 link

**A****Even number of links**

Up to a pitch of 19,05 mm

Pitch as of 25,4 mm

**B****Odd number of links**

Up to a pitch of 19,05 mm

Pitch as of 25,4 mm

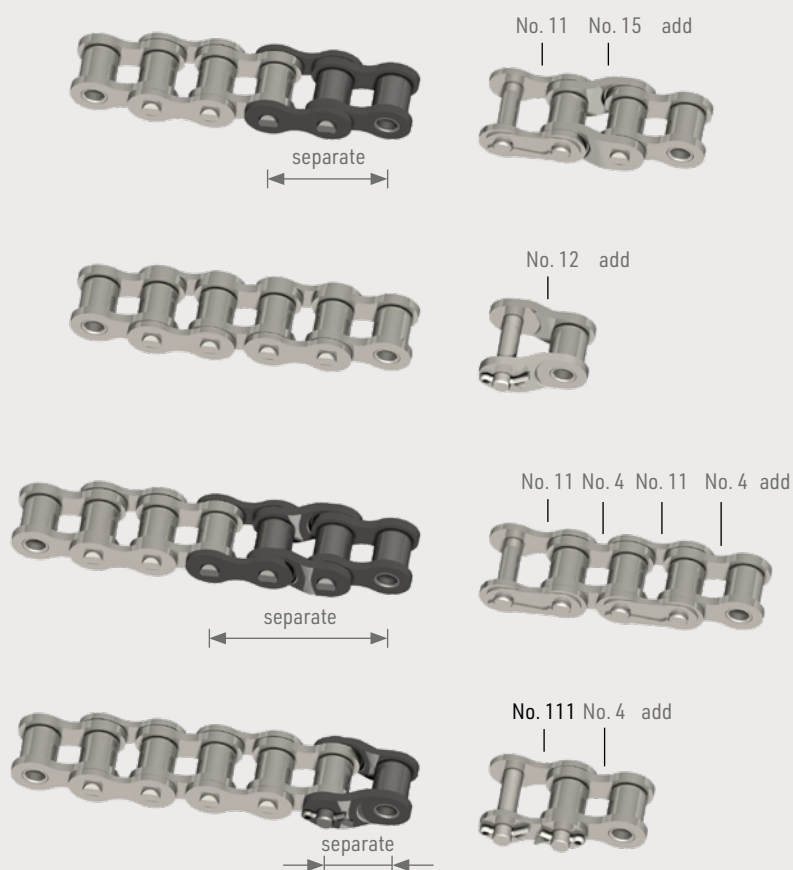

## Extending by 1 link

**A****Even number of links**

Up to a pitch of 19,05 mm

Pitch as of 25,4 mm

**B****Odd number of links**

Up to a pitch of 19,05 mm

Pitch as of 25,4 mm

Please note: When cranked links are used, roller chains may only have 80 % of the tensile strength.

WIPPERMANN JR. GMBH TRADING

Albert-Einstein-Str. 1

32278 Kirchlegern

Germany

Phone +49 23317820

Fax +49 2331782356

E-mail [witra@wippermann.com](mailto:witra@wippermann.com)

Internet [www.witra.com](http://www.witra.com)